

KOSTAL Smart Energy Meter

Power measuring device - G1 series



Operating manual

Legal notice

KOSTAL Solar Electric GmbH
Hanferstraße 6
79108 Freiburg i. Br.
Germany
Tel. +49 (0)761 477 44-100
Fax +49 (0)761 477 44-111

www.kostal-solar-electric.com

Exclusion of liability

All names, trademarks, product names and other designations used in this manual may be legally protected even if not indicated as such (e.g. as a trademark). KOSTAL Solar Electric GmbH assumes no liability for their free usage. The illustrations and texts have been compiled with great care. However, the possibility of errors cannot be ruled out. The compilation is made without any guarantee.

General note on gender equality

KOSTAL Solar Electric GmbH is aware of how language impacts on gender equality and always makes an effort to reflect this in documentation. Nevertheless, for the sake of readability we are unable to use non-gender-specific terms throughout and use the masculine form instead.

© 2024 KOSTAL Solar Electric GmbH

All rights reserved by KOSTAL Solar Electric GmbH, including those of reproduction by photocopy and storage in electronic media. Commercial use or distribution of the texts, models, diagrams and photographs appearing in this product is not permitted. This manual may not be reproduced, stored, transmitted or translated in any form or by means of any medium, in whole or in part, without prior written permission.

Contents

1.	General information.....	5
1.1	Contact	6
1.2	About this manual	7
1.3	Exclusion of liability.....	8
1.4	Target group	9
1.5	Proper use	10
1.6	Open Source licence	11
1.7	EU declarations of conformity.....	12
1.8	Notes in this manual.....	13
1.9	Navigation in the document	15
1.10	Labels on the energy meter	16
2.	Device and system description	17
2.1	Using the KOSTAL Smart Energy Meter	18
2.2	The KOSTAL Smart Energy Meter	20
2.3	LED statuses.....	21
2.4	Functions	22
3.	Connection variants	25
3.1	KSEM with PLENTICORE.....	27
3.2	KSEM with PLENTICORE BI.....	32
3.3	KSEM with PIKO IQ.....	34
3.4	KSEM with PIKO MP plus.....	37
3.5	KSEM with PIKO 4.2-20 / PIKO EPC.....	46
3.6	KSEM with PIKO CI.....	48
3.7	KSEM with ENECTOR AC 3.7/11 wallbox	53
3.8	KSEM with PLENTICORE and ENECTOR AC 3.7/11 wallbox.....	58
3.9	KSEM with PIKO MP plus and ENECTOR AC 3.7/11 wallbox.....	59
3.10	Multiple-inverter connection of KOSTAL inverters	61
3.11	Configuring settings in the Webserver.....	69
4.	Operation	70
4.1	The Webserver	72
4.2	Preparing KOSTAL Smart Energy Meter	73
4.3	Calling up user interface	74
4.4	Configuring settings.....	76
4.5	The dashboard.....	77
4.6	Menu - smart meter.....	78
4.7	Menu – wallbox	79

4.8	Menu – tariff	95
4.9	Menu - plant overview/settings	98
4.10	Menu - activation code	102
4.11	Menu - inverter	103
4.12	Menu - solar portal	109
4.13	Menu - Modbus settings.....	110
4.14	Menu - device settings	118
5.	Faults / maintenance.....	124
5.1	Functions of the reset button	125
5.2	Error messages / displays	126
5.3	Exporting log data	127
5.4	Updating device firmware	128
5.5	Change password	129
5.6	Access tokens.....	130

1. General information

1.1	Contact.....	6
1.2	About this manual.....	7
1.3	Exclusion of liability	8
1.4	Target group.....	9
1.5	Proper use.....	10
1.6	Open Source licence.....	11
1.7	EU declarations of conformity	12
1.8	Notes in this manual.....	13
1.9	Navigation in the document.....	15
1.10	Labels on the energy meter.....	16

1.1 Contact

Thank you for choosing a device from KOSTAL Solar Electric GmbH.

If you have any technical questions, please call our service hotline:

Warranty and service

Please have the following information to hand for speedy processing:

- Type designation
- Serial number (see type plate on the device)

1.2 About this manual

Read this manual carefully in its entirety.

It contains important information about installation and operation. Pay particular attention to the information regarding safe usage. KOSTAL Solar Electric GmbH assumes no liability for damages arising from non-observance of this manual.

This manual is an integral part of the product. It applies exclusively to the device from KOSTAL Solar Electric GmbH. Keep this manual and give it to the new owner should you pass it onto a new operator.

The installer and the operator must have unrestricted access to these instructions at all times. The installer must be familiar with this manual and follow all instructions.

The most recent version of the operating manual for your product is available in the download area at www.kostal-solar-electric.com.

1.3 Exclusion of liability

Any use that deviates from or goes beyond the proper use described is considered improper use. The manufacturer accepts no liability for any damage resulting from this. Modifications to the device are prohibited. The device may only be used if it is safe to operate and is in a technically perfect condition. Any instance of misuse will result in the termination of the warranty, guarantee and general liability of the manufacturer.

i INFO

The device may only be installed, maintained and repaired by a trained and qualified electrician.

Only a qualified electrician may open the device. The device must be installed by a trained electrician (according to DIN VDE 1000-10 or BGV A3 accident prevention regulations or an internationally comparable standard) who is responsible for observing the applicable standards and regulations.

The electrician is responsible for ensuring that the applicable standards and regulations are observed and implemented. Work that could affect the electrical power system of the relevant energy supply company at the site may only be carried out by qualified electricians expressly authorised (licensed) by the energy supply company.

This includes changes to the factory-preset parameters.

Work that could affect the electrical power system of the relevant energy supply company at the site may only be carried out by qualified electricians expressly authorised (licensed) by the energy supply company. This includes changes to the factory-preset parameters. The installer must always observe the regulations of the energy supply company.

Factory settings may only be changed by qualified electrical installers or persons with at least comparable or higher technical qualifications, e.g. trades professionals, technicians or engineers. When doing so, all requirements are to be observed.

1.4 Target group

Operator

As the operator, you are responsible for the device. You are responsible for the proper use and safe use of the device. This also includes instructing people using the device.

As an operator without specialist electrical training, you may only carry out activities that do not require an electrician.

Electrician

As an electrician, you have recognised electrical engineering training. On the basis of this expertise, you are authorised to carry out the electrical work required in this manual.

Requirements of an electrician:

- Knowledge of general and specific safety and accident prevention regulations.
- Knowledge of electrical regulations.
- Knowledge of national regulations.
- Ability to recognise risks and avoid possible hazards.

Qualification

Some activities in this manual require expertise in electrical engineering. If activities are carried out by someone without the necessary knowledge and qualifications, serious accidents and death may result.

- Only carry out activities for which you have been qualified and instructed.
- Observe the references to electricians in this manual.

1.5 Proper use

The KOSTAL Smart Energy Meter is a measuring device, which determines electrical measuring values and is available to the inverter via LAN or RS485. It is not an electricity meter for measuring active consumption in the sense of the EU Directive 2004/22/EC (MID) and it may only be used for internal purposes.

The data about your system's energy generation collected by the KOSTAL Smart Energy Meter may deviate from the data of the main energy meter.

According to its classification as overvoltage category III, the KOSTAL Smart Energy Meter may only be connected in the sub-distribution / circuit distribution on the consumer side behind the energy supply company's energy meter and is only suitable for indoor use.

The KOSTAL Smart Energy Meter is approved for use in EU member states. Only use the KOSTAL Smart Energy Meter in accordance with the details provided in the enclosed documentation.

Any other form of use may result in damage to property or personal injury. For reasons of safety, the product (including the software) must not be modified and components must not be fitted if they are not expressly recommended or sold by KOSTAL Solar Electric GmbH for this product. Any form of product use other than that described in the intended use section is not considered to be intended.

Operators are prohibited from undertaking unauthorised changes, conversions and repairs as well as opening the product.

The enclosed documentation forms part of the product and must be read, noted and kept accessible at all times.

1.6 Open Source licence

This product contains Open Source software, developed by third parties and licensed using vehicles including GPL and/or LGPL.

For more details on this, a list of the Open Source software used and the related licence texts, go to the Licences section on the device's website (Webserver).

1.7 EU declarations of conformity

KOSTAL Solar Electric GmbH hereby declares that the devices described in this document complies with the basic requirements and other relevant conditions of the directives listed below.

- Directive 2014/30/EU
(on the harmonisation of the laws of the Member States relating to electromagnetic compatibility (EMC))
- Directive 2014/35/EU
(on the harmonisation of the laws of the Member States relating to the making available on the market of electrical equipment designed for use within certain voltage limits Low Voltage Directive)
- Directive 2011/65/EU
(RoHS) to limit the use of certain hazardous substances in electrical and electronic equipment

You will find a detailed EU Declaration of Conformity for the product in the download area at:

www.kostal-solar-electric.com

1.8 Notes in this manual

A distinction is made in this manual between warnings and information notes. All notes are identified in the text line with an icon.

Warnings

The warnings refer to life-threatening dangers. Serious injuries possibly resulting in death may occur.



DANGER

Indicates a direct hazard with a high level of risk, which, if not avoided, will result in death or serious injury.



WARNING

Indicates a hazard with a moderate level of risk, which, if not avoided, will result in death or serious injury.



CAUTION

Indicates a hazard with a low level of risk, which, if not avoided, will result in minor or slight injury or property damage.



IMPORTANT INFORMATION

Indicates a hazard with a low level of risk, which, if not avoided, may result in damage to property.



INFO

Information notes contain important instructions for the installation and problem-free operation of the device. These must be followed at all times. The information notes also point out that failure to observe instructions may result in damage to property or financial damages.

Warning symbols



Danger



Danger due to electrical shock and discharge



Danger due to burns

Symbols within the information notes



The symbol indicates activities that may only be carried out by an electrician.



Information or tip



Important information



Damage to property possible

1.9 Navigation in the document

In order to enable navigation through this document, it contains clickable areas.



The table of contents takes you to the specified chapter in one click.

You can navigate to the referenced points in the document within the instruction text using the cross-references.

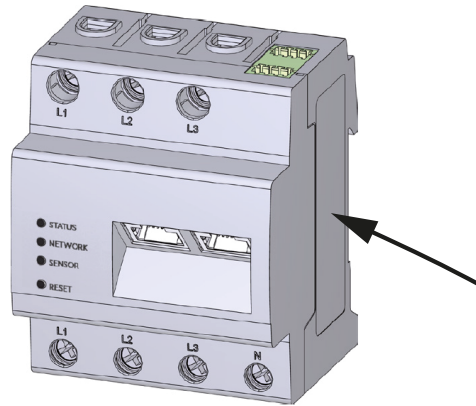
1.10 Labels on the energy meter

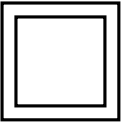

Signs and labels are attached to the housing of the energy meter. These signs and labels may not be altered or removed.

Symbol	Explanation
	Electrical installations require specialist skills
	Housing with protective insulation (protective class II).
	Device may not be disposed of with household waste. Observe the local application of disposal requirements
	CE marking The product satisfies the applicable EU requirements

2. Device and system description

2.1 Using the KOSTAL Smart Energy Meter	18
2.2 The KOSTAL Smart Energy Meter.....	20
2.3 LED statuses	21
2.4 Functions.....	22

2.1 Using the KOSTAL Smart Energy Meter

The KOSTAL Smart Energy Meter (KSEM) is a measuring device, which determines electrical measuring values at the grid connection point and is available via LAN or RS485. It can be used in combination with various KOSTAL solar inverters and the KOSTAL wallbox.

This includes the following inverters:

- PLENTICORE plus
- PLENTICORE G3
- PLENTICORE BI
- PIKO IQ
- PIKO MP plus
- PIKO 4.2-20
- PIKO CI
- PIKO EPC

The inverters can be used in combination with the KOSTAL Smart Energy Meter for the following applications:

- Reading the current home consumption and output power
- Power curtailment of inverters down to 0 W

INFO

If a battery storage system and other KOSTAL inverters are used in the system, the maximum possible curtailment is to 50 % of the generator output (kWp).

- With a multiple-inverter connection with several PV inverters in the same house grid, only one KOSTAL Smart Energy Meter is required at the grid connection point.
- If using PIKO MP plus with a battery, battery management, which controls the battery's charging / discharging, is handled by the KOSTAL Smart Energy Meter.
- Sending consumption data to the KOSTAL Solar Portal.

This includes the following wallbox:

- ENECTOR AC 3.7/11

The wallbox can be used in combination with the KOSTAL Smart Energy Meter and KOSTAL inverters for the following applications:

- Blackout protection (house connection monitoring)
Here, the house connection is monitored when charging the electric vehicle. If the maximum connected load (e.g. 63 A) is exceeded, the charging power is reduced or charging is interrupted.
- ENECTOR with convenience function
These include advanced ENECTOR charging modes (e.g. Lock Mode, Power Mode, Solar Pure Mode, Solar Plus Mode). Some modes only work in combination with a KOSTAL inverter.

2.2 The KOSTAL Smart Energy Meter

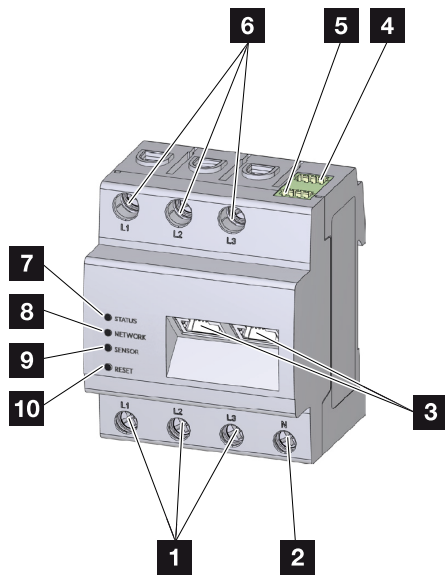

- 1 Inputs for external wires L1, L2, L3
- 2 Neutral wire N
- 3 2 x LAN connection
- 4 RS485 connection (A) Pre-configured for PIKO IQ/PLENTICORE
- 5 RS485 connection (B) Pre-configured for PIKO MP plus
- 6 Outputs for external wires L1, L2, L3
- 7 Status LED
- 8 Network LED
- 9 Sensor LED for RS485 bus
- 10 Reset button

2.3 LED statuses

The LEDs inform the user of the status of the KOSTAL Smart Energy Meter.

The following statuses are indicated:

Status LED

Colour	State	Description
Orange	On (<10 s)	Device starting
Green	Flashes slowly	
Green	On	Device ready
Green	Flashes quickly	Firmware update active
Yellow	Flashes 2 x	Confirmation for resetting the network settings using the Reset button for resetting the device password.
Red	On	Error
Red	Flashes	❏ Error messages / displays, Page 126
Orange	On (>10 s)	

Network LED

Colour	State	Description
-	Off	No connection
Green	On	Network connection is being established
Green	Flashes	Network connection is active

Serial bus LED

Colour	State	Description
-	Off	No connection
Green	Flashes quickly	Connection active
Green	Flashes slowly	Scan process active
Red	On	Error - overload at 5 V output VCC
Orange	Flashes	Error – receiver not responding

2.4 Functions

Recording home consumption

Using the KOSTAL Smart Energy Meter enables the inverter to monitor the flow of energy in the home 24 hours a day and to control it in an optimum manner.

The inverter primarily handles control. The PV energy generated is used firstly for self-consumption (such as lighting, the washing machine or TV). Only once self-consumption is covered can the energy generated above and beyond this be stored in a battery or fed into the public grid.

- Using energy meter (Modbus RTU) to record home consumption
- 24-hour measurement

Multiple-inverter connection

With a multiple-inverter connection, there are several KOSTAL solar inverters in the same house grid. By installing the KOSTAL Smart Energy Meter at the grid connection point, the flow of energy from all KOSTAL solar inverters present in the house grid can be measured and regulated by the KOSTAL Smart Energy Meter using control information, e.g. for power limitation in order to limit the feed-in to the public grid. The benefit of this setup is that only one energy meter is required for all KOSTAL solar inverters in the house grid.

- Simultaneous power curtailment of several KOSTAL solar inverters in the same house grid
- Saving costs by using just one energy meter

Battery management for PIKO MP plus with connected battery

The PIKO MP plus is not able to control a connected battery itself. In order to do this, the PIKO MP plus also needs the KOSTAL Smart Energy Meter and a battery activation code, both of which can be obtained from our KOSTAL Solar online shop. The KOSTAL Smart Energy Meter then handles battery management and transmits control information to the PIKO MP plus for this purpose.

Communication between KOSTAL solar inverters and KOSTAL Smart Energy Meter

The KOSTAL Smart Energy Meter provides various interfaces for communication purposes. These establish a connection to other KOSTAL solar inverters, sensors or the Internet.

- LAN
LAN connects the KOSTAL Smart Energy Meter to the local home network, via which it can then access other inverters or the Internet and Solar Portal.
- RS485/Modbus (RTU)
Inverters or other devices approved by KOSTAL Solar Electric, via which information or control commands are transmitted, are connected to the Modbus interface.

Communication between KOSTAL wallbox and KOSTAL Smart Energy Meter

The KOSTAL Smart Energy Meter has an RS485 interface for communication with KOSTAL wallboxes.

- RS485/Modbus (RTU)
A KOSTAL wallbox can be connected to the Modbus interface, via which information or control commands are transmitted.

The Webserver

The Webserver is the graphical interface for querying and configuring the KOSTAL Smart Energy Meter.

Supported web browsers

The KOSTAL Smart Energy Meter's web interface is optimised for the following web browsers. We recommend using one of the web browsers listed below to ensure that the web interface can be used smoothly.

- Microsoft Edge
- Mozilla Firefox
- Apple Safari
- Google Chrome

Unsupported web browser

- Microsoft Internet Explorer

The Webserver provides the following functions:

- Logging in to the energy meter
- Querying the status
- Current yield values/consumption values
- Configuring the KOSTAL Smart Energy Meter (e.g. software updates [various modes], releasing options, incorporating PV systems for multiple-inverter connection, etc.)

- RS485/Modbus (RTU)
Inverters, batteries or other devices approved by KOSTAL Solar Electric, via which information or control commands are transmitted, are connected to the Modbus interface.
- Release of extra options
This function (which can be found by going to ***Inverter > Activation code***) can be used to release additional options. This may include e.g. releasing battery management in the KOSTAL Smart Energy Meter to connect a battery to the PIKO MP plus.
- Calling up the error log file
- Backup for saving data and the configuration

For more information, see  **Operation, Page 70.**

The data logger

A data logger is integrated in the KOSTAL Smart Energy Meter. The data logger is a data storage system, which collects and stores the error information. Such information is required by the service team in the event of an error.

For more information, see  **Exporting log data, Page 127.**

KOSTAL Solar Portal

The KOSTAL Solar Portal protects your investment in a PV system against yield losses, e.g. through active e-mail alerts of events.

You can log in to the KOSTAL Solar Portal for free at www.kostal-solar-portal.com.

Functions include:

- Worldwide online access to the portal
- Graphic representation of the power and yield data
- Visualisation of data and thus being made aware of how to optimise self-consumption
- Notification of events by e-mail
- Data export
- Sensor evaluation
- Display and proof of a potential active power reduction by the grid operator
- Storage of log data for long-term and reliable monitoring of your PV system

You can find more information about this product on our website www.kostal-solar-electric.com by going to ***Products***.

3. Connection variants

3.1	KSEM with PLENTICORE.....	27
3.1.1	PLENTICORE - load/generation measurement.....	27
3.1.2	PLENTICORE - additional scope for storage from AC energy sources.....	30
3.2	KSEM with PLENTICORE BI	32
3.2.1	PLENTICORE BI - scope for storage from AC energy sources	32
3.3	KSEM with PIKO IQ	34
3.3.1	PIKO IQ - load/generation measurement.....	34
3.4	KSEM with PIKO MP plus	37
3.4.1	PIKO MP plus - load/generation measurement.....	38
3.4.2	PIKO MP plus - battery control.....	41
3.4.3	Setting up a new battery with an existing PIKO MP plus.....	45
3.5	KSEM with PIKO 4.2-20 / PIKO EPC	46
3.5.1	PIKO 4.2-20 / PIKO EPC - load/generation measurement.....	46
3.6	KSEM with PIKO CI.....	48
3.6.1	PIKO CI - load/generation measurement - connection via LAN.....	48
3.6.2	PIKO CI - load/generation measurement - connection via RS485.....	51
3.7	KSEM with ENECTOR AC 3.7/11 wallbox.....	53
3.7.1	ENECTOR with KOSTAL Smart Energy Meter for blackout protection (house connection monitoring).....	53
3.7.2	Setting up ENECTOR with convenience functions in the KSEM.....	54
3.8	KSEM with PLENTICORE and ENECTOR AC 3.7/11 wallbox.....	58
3.9	KSEM with PIKO MP plus and ENECTOR AC 3.7/11 wallbox	59
3.10	Multiple-inverter connection of KOSTAL inverters.....	61
3.10.1	Procedure.....	62
3.10.2	Communication connection	63
3.10.3	Activating Modbus protocol	64
3.10.4	Configuring settling time.....	64
3.10.5	Settings in the KOSTAL Smart Energy Meter.....	65
3.10.6	Adding KOSTAL inverters in the KOSTAL Smart Energy Meter.....	66

3.10.7	Setting up devices in the KOSTAL Solar Portal.....	67
3.10.8	Configuring power curtailment.....	68
3.11	Configuring settings in the Webserver	69

3.1 KSEM with PLENTICORE

The KOSTAL Smart Energy Meter (KSEM) can be used in conjunction with the PLENTICORE in the following variants.

- 24-hour load/generation measurement
- (measure the current home consumption and output power)
- DC energy storage (from your own PV system)
- Scope for storage from AC energy sources (e.g. from PV systems, wind turbines, combined heat and power units)
- Multiple-inverter connection
- (several KOSTAL solar inverters in the same house grid, only one KOSTAL Smart Energy Meter is required). **☑ Multiple-inverter connection of KOSTAL inverters, Page 61**
- Dynamic active power control
- Provision of measurement data when using battery functionality in conjunction with PLENTICORE

3.1.1 PLENTICORE - load/generation measurement

Installation position - home consumption (position 1)

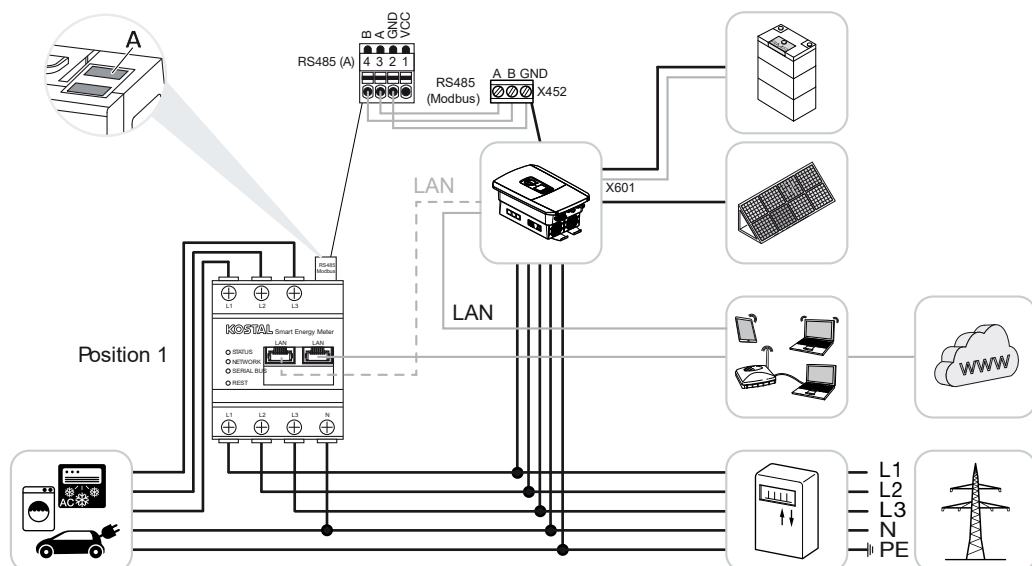

Installation position - grid connection point (position 2 - standard)

3. Connection variants

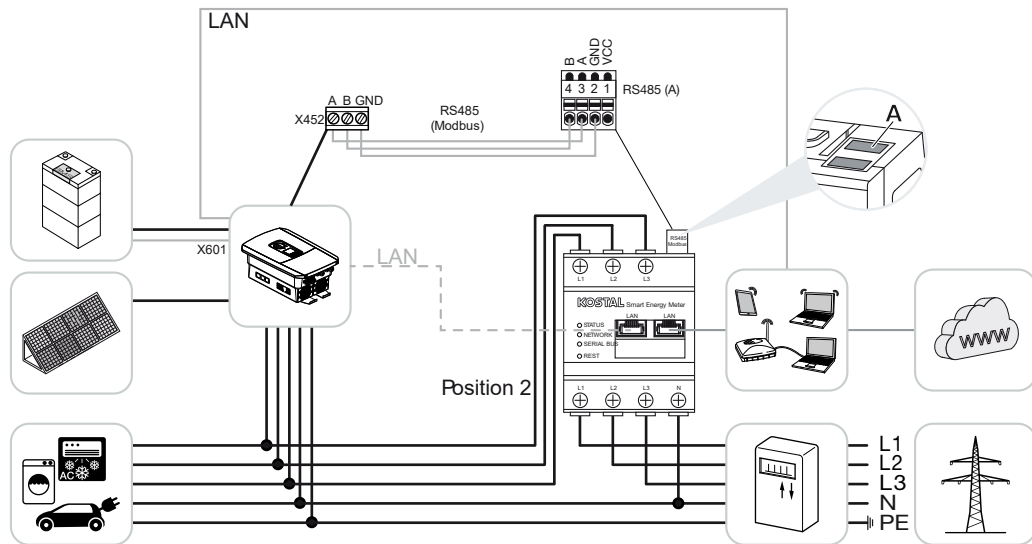

Install the KOSTAL Smart Energy Meter in the house grid as shown.

i INFO

The installation position of the KOSTAL Smart Energy Meter is set in the inverter.

Set up RS485 communication cable between inverter and KOSTAL Smart Energy Meter and connect.

Establish LAN connection from KOSTAL Smart Energy Meter and inverter to the Internet. As an option, the LAN connection from the inverter can also be connected directly to the KOSTAL Smart Energy Meter (switch function).

i INFO

For details, see the inverter's operating manual and the KOSTAL Smart Energy Meter's installation instructions.

In this variant, the KOSTAL Smart Energy Meter runs as a slave and transmits data to the inverter.

The inverter does not have to be set up in the KOSTAL Smart Energy Meter because it is pre-configured to the Modbus RTU RS485 interface (A) as standard.

If changes are to be made to the settings, perform the following steps:

1. Call up online interface of KOSTAL Smart Energy Meter **Calling up user interface, Page 74**
2. Call up Modbus configuration under Modbus settings.
3. Select **PIKO IQ/PLENTICORE** from drop-down list
Press the **Save** button to adopt the settings.

INFO

When an inverter is selected, the predefined default values are adopted. These can be adapted if necessary.

Parameter	Value
Interface	RS485 A
Mode	Slave
Presetting	PIKO IQ/PLENTICORE
Slave address	1
Baud rate	38400
Data bits	8
Parity	None
Stop bit	2

3.1.2 PLENTICORE - additional scope for storage from AC energy sources

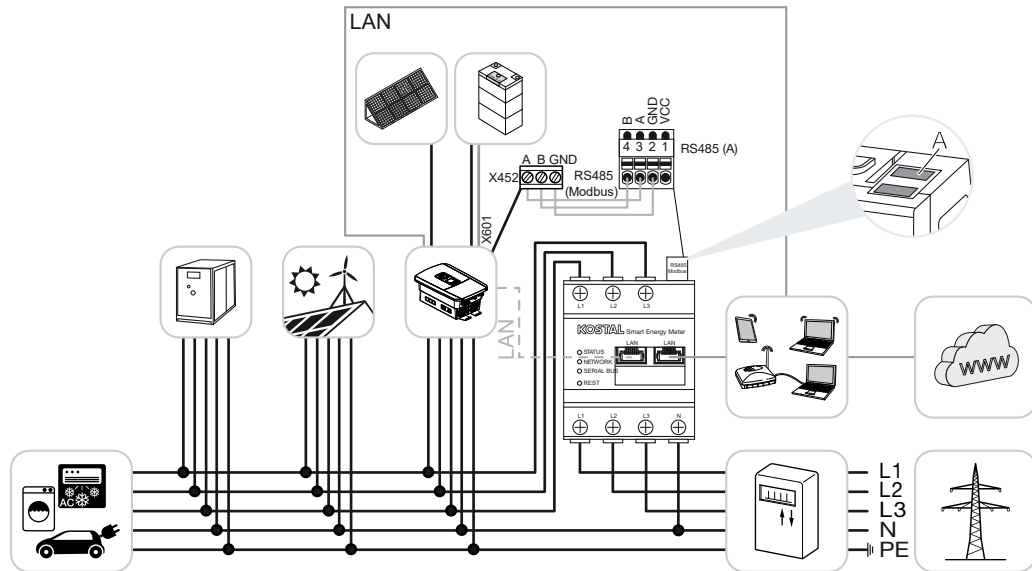

Install KOSTAL Smart Energy Meter as shown at the grid connection point (position 2) in the house grid.

i INFO

The installation position of the KOSTAL Smart Energy Meter is set in the inverter.

Set up RS485 communication cable between inverter and KOSTAL Smart Energy Meter and connect.

Establish LAN connection from KOSTAL Smart Energy Meter and inverter to the Internet. As an option, the LAN connection from the inverter can also be connected directly to the KOSTAL Smart Energy Meter (switch function).

i INFO

For details, see the inverter's operating manual and the KOSTAL Smart Energy Meter's installation instructions.

In this variant, the KOSTAL Smart Energy Meter runs as a slave and transmits data to the inverter.

The inverter does not have to be set up in the KOSTAL Smart Energy Meter because it is pre-configured to the Modbus RTU RS485 interface (A) as standard.

In the inverter, "Storage of excess AC energy from local generation" must be activated by going to **Service menu > Energy management**.

i INFO

For details, refer to the inverter's operating manual. Setting on inverter only possible after logging in as an installer.

If changes are to be made to the settings, perform the following steps:

1. Call up online interface of KOSTAL Smart Energy Meter **Calling up user interface, Page 74**
2. Call up Modbus configuration under Modbus settings.
3. Select **PIKO IQ/PLENTICORE** from drop-down list
Press the **Save** button to adopt the settings.

i INFO

When an inverter is selected, the predefined default values are adopted. These can be adapted if necessary.

4. In the inverter, activate **Storage of excess AC energy from local generation** by going to **Service menu > Energy management**.

i INFO

For details, refer to the inverter's operating manual. Setting on inverter only possible after logging in as an installer.

Parameter	Value
Interface	RS485 A
Mode	Slave
Presetting	PIKO IQ/PLENTICORE
Slave address	1
Baud rate	38400
Data bits	8
Parity	None
Stop bit	2

3.2 KSEM with PLENTICORE BI

The KOSTAL Smart Energy Meter (KSEM) can be used in conjunction with the PLENTICORE BI in the following variants.

- Scope for storage from AC energy sources (e.g. from PV systems, wind turbines, combined heat and power units)
- Provision of measurement data

3.2.1 PLENTICORE BI - scope for storage from AC energy sources

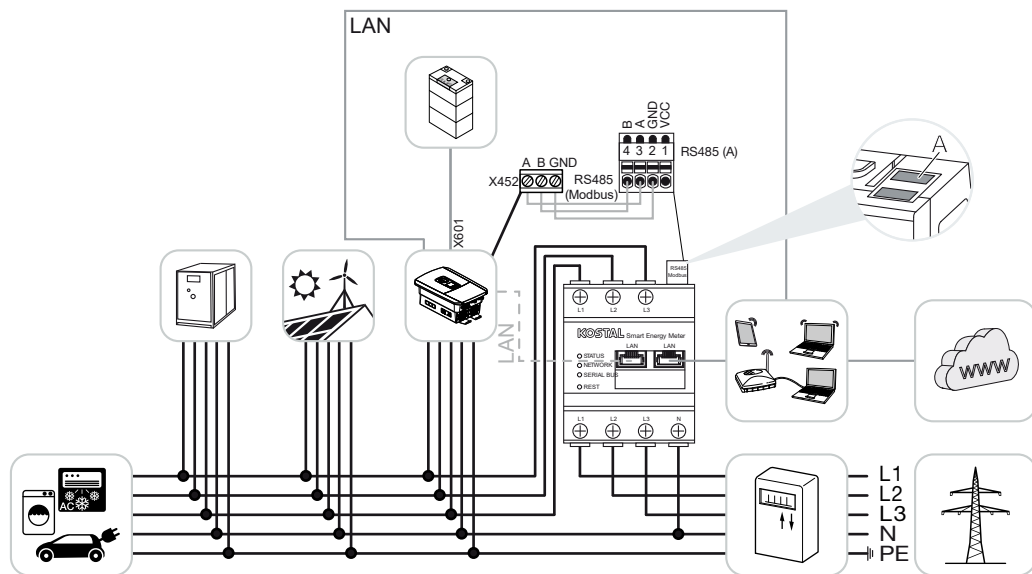

Install KOSTAL Smart Energy Meter as shown at the grid connection point (position 2) in the house grid.

Set up RS485 communication cable between inverter and KOSTAL Smart Energy Meter and connect.

Establish LAN connection from KOSTAL Smart Energy Meter and inverter to the Internet. As an option, the LAN connection from the inverter can also be connected directly to the KOSTAL Smart Energy Meter (switch function).

i INFO

For details, see the inverter's operating manual and the KOSTAL Smart Energy Meter's installation instructions.

In this variant, the KOSTAL Smart Energy Meter runs as a slave and transmits data to the inverter.

The inverter does not have to be set up in the KOSTAL Smart Energy Meter because it is pre-configured to the Modbus RTU RS485 interface (A) as standard.

If changes are to be made to the settings, perform the following steps:

1. Call up online interface of KOSTAL Smart Energy Meter **Calling up user interface, Page 74**
2. Call up Modbus configuration under Modbus settings.
3. Select **PIKO IQ/PLENTICORE** from drop-down list
Press the **Save** button to adopt the settings.

INFO

When an inverter is selected, the predefined default values are adopted. These can be adapted if necessary.

Parameter	Value
Interface	RS485 A
Mode	Slave
Presetting	PIKO IQ/PLENTICORE
Slave address	1
Baud rate	38400
Data bits	8
Parity	None
Stop bit	2

3.3 KSEM with PIKO IQ

The KOSTAL Smart Energy Meter (KSEM) can be used in conjunction with the PIKO IQ in the following variants.

- 24-hour load/generation measurement (measuring the current home consumption and output power)
- Multiple-inverter connection (several KOSTAL solar inverters in the same house grid, only one KOSTAL Smart Energy Meter is required for this) **☑ Multiple-inverter connection of KOSTAL inverters, Page 61**
- Dynamic active power control

3.3.1 PIKO IQ - load/generation measurement

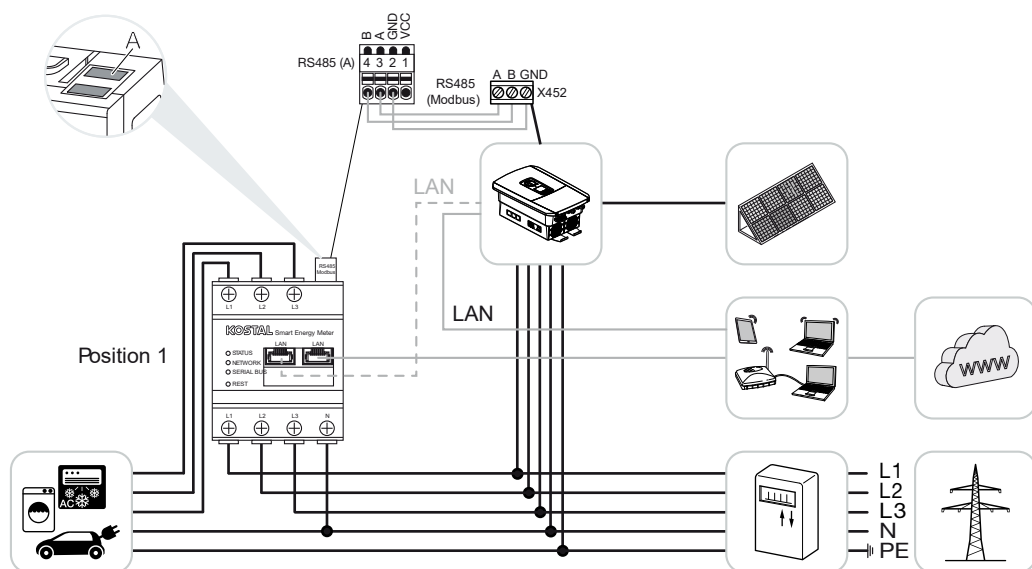

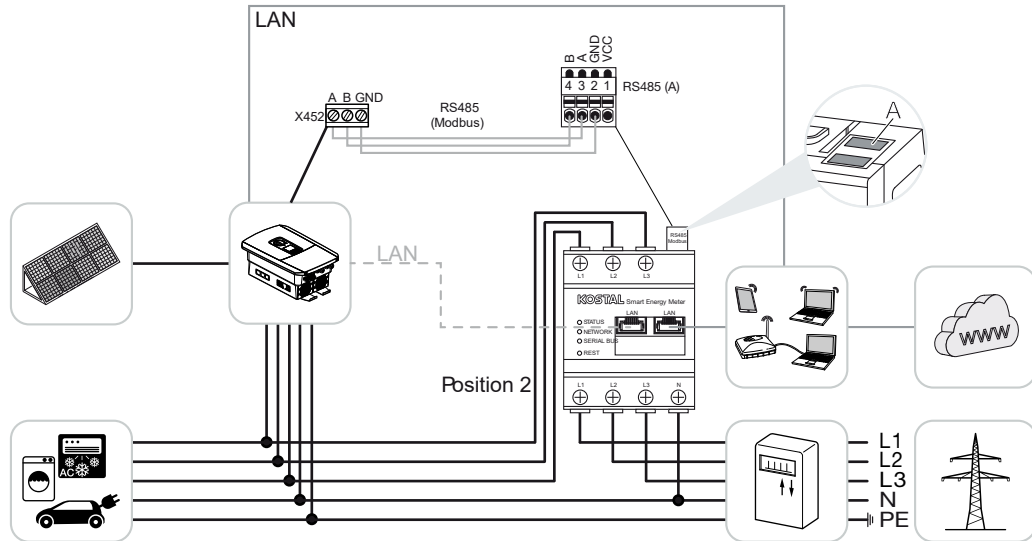

Install KOSTAL Smart Energy Meter as shown for home consumption (position 1) or at the grid connection point (position 2 - standard) in the house grid.

i INFO

The installation position of the KOSTAL Smart Energy Meter is set in the inverter.

Set up RS485 communication cable between inverter and KOSTAL Smart Energy Meter and connect.

Establish LAN connection from KOSTAL Smart Energy Meter and inverter to the Internet. As an option, the LAN connection from the inverter can also be connected directly to the KOSTAL Smart Energy Meter (switch function).

i INFO

For details, see the inverter's operating manual and the KOSTAL Smart Energy Meter's installation instructions.

In this variant, the KOSTAL Smart Energy Meter runs as a slave and transmits data to the inverter.

The inverter does not have to be set up in the KOSTAL Smart Energy Meter because it is pre-configured to the Modbus RTU RS485 interface (A) as standard.

If changes are to be made to the settings, perform the following steps:

1. Call up online interface of KOSTAL Smart Energy Meter **Calling up user interface, Page 74**
2. Call up Modbus configuration under Modbus settings.
3. Select **PIKO IQ/PLENTICORE** from drop-down list
Press the **Save** button to adopt the settings.

INFO

When an inverter is selected, the predefined default values are adopted. These can be adapted if necessary.

Parameter	Value
Interface	RS485 A
Mode	Slave
Presetting	PIKO IQ/PLENTICORE
Slave address	1
Baud rate	38400
Data bits	8
Parity	None
Stop bit	2

3.4 KSEM with PIKO MP plus

The KOSTAL Smart Energy Meter (KSEM) can be used in conjunction with the PIKO MP plus in the following variants.

- 24-hour load/generation measurement (measuring the current home consumption and output power)
- Multiple-inverter connection (several KOSTAL solar inverters in the same house grid, only one KOSTAL Smart Energy Meter is required for this) **☑ Multiple-inverter connection of KOSTAL inverters, Page 61**
- Dynamic active power control
- Control (charge/discharge) a battery connected to the PIKO MP plus. **☑ PIKO MP plus - battery control, Page 41**
- Provision of measurement data during battery functionality.

3.4.1 PIKO MP plus - load/generation measurement

Installation position – home consumption (position 1)

The installation position cannot be used for a PIKO MP plus with battery or in a multiple-inverter connection.

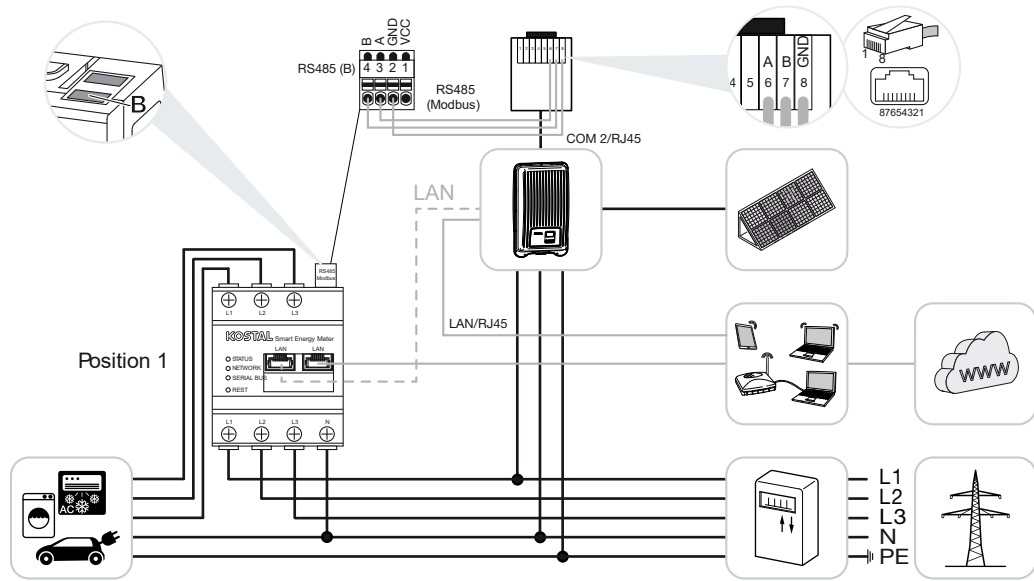

Installation position – grid connection point (position 2 – standard)

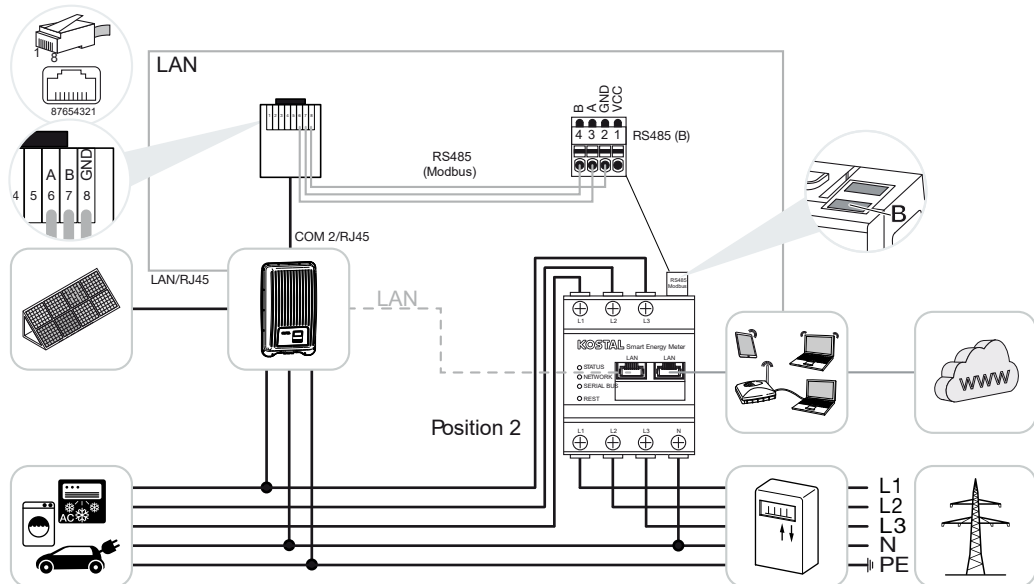

Install the KOSTAL Smart Energy Meter in the house grid as shown.

i INFO

The installation position of the KOSTAL Smart Energy Meter is set in the inverter.

Set up RS485 communication cable between inverter and KOSTAL Smart Energy Meter and connect.

Establish LAN connection from KOSTAL Smart Energy Meter and inverter to the Internet. As an option, the LAN connection from the inverter can also be connected directly to the KOSTAL Smart Energy Meter (switch function).

i INFO

When an inverter is selected, the predefined default values are adopted. These can be adapted if necessary.



i INFO

For details, see the inverter's operating manual and the KOSTAL Smart Energy Meter's installation instructions.

In this variant, the KOSTAL Smart Energy Meter runs as a slave and transmits data to the inverter.

The inverter does not have to be set up in the KOSTAL Smart Energy Meter because it is pre-configured to the Modbus RTU RS485 interface (B) as standard.

If changes are to be made to the settings, perform the following steps:

1. Call up online interface of KOSTAL Smart Energy Meter  **Calling up user interface, Page 74**
2. Call up Modbus configuration under Modbus settings.
3. Select the **PIKO MP plus** from drop-down list 
Press the **Save** button to adopt the settings.

i INFO

When an inverter is selected, the predefined default values are adopted. These can be adapted if necessary.

Parameter	Value
Interface	RS485 B
Mode	Slave
Presetting	PIKO MP plus
Slave address	247
Baud rate	19200

3. Connection variants

Parameter	Value
Data bits	8
Parity	Even
Stop bit	1

3.4.2 PIKO MP plus - battery control

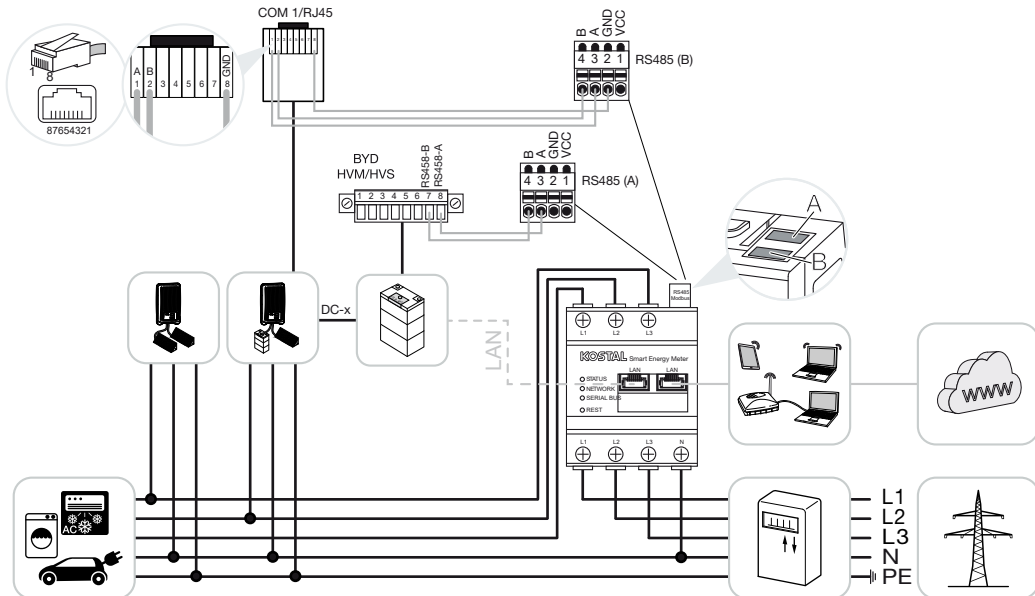

Install the KOSTAL Smart Energy Meter at the grid connection point in the house grid as shown.

i INFO

The installation position of the KOSTAL Smart Energy Meter can no longer be set in the PIKO MP plus when battery management is activated in the KOSTAL Smart Energy Meter. It is absolutely essential that the KOSTAL Smart Energy Meter is fitted at the grid connection point.

Set up RS485 communication cable between inverter and KOSTAL Smart Energy Meter RS485 (B) and connect.

Set up RS485 communication cable between battery and KOSTAL Smart Energy Meter RS485 (A) and connect.

Establish LAN connection from KOSTAL Smart Energy Meter, battery and inverter to the Internet. As an option, the LAN connection from the inverter or battery can also be connected directly to the KOSTAL Smart Energy Meter (switch function).

i INFO

For details, see the inverter's operating manual and the KOSTAL Smart Energy Meter's installation instructions.

In this variant, the KOSTAL Smart Energy Meter runs as a master and transmits data to the inverter and battery.

- When setting up, note the following installation order:

INFO

The battery must be assigned to a DC input in the PIKO MP plus. This is done in the PIKO MP plus by going to **Settings > Service > Inputs > DCx > Battery**.

- Switch off inverter by pressing DC switch
- Switch off battery using main switch
- Switch on battery using main switch
- Set up inverter and battery in KOSTAL Smart Energy Meter
- Switch on inverter by pressing DC switch

INFO

Nature and source of hazard

If the battery is switched off manually for any reason, observe the following order for switching on:

- Switch off inverter
- Switch on battery
- Switch on inverter

The PIKO MP plus and battery must be set up in the KOSTAL Smart Energy Meter.

Do this by performing the following steps:

1. Call up online interface of KOSTAL Smart Energy Meter  **Calling up user interface, Page 74**
2. For a battery to be used with the PIKO MP plus, the function for this must be released in the KOSTAL Smart Energy Meter. To do this, activate the battery management under **Activation code** .

INFO

Input of an activation code, e.g. to connect a battery. This first has to be purchased from the KOSTAL Solar online shop.

3. Then you can set up the devices. To do this, go to **Inverter > Devices** (manage the inverters used).
4. Use the plus symbol to add an inverter.

i INFO

When an inverter is selected, the predefined default values are adopted. These can be adapted if necessary.

Parameter	Value
Series	Select PIKO MP plus.
Type	Select the appropriate type/power class of the inverter. This automatically sets the inverter's maximum AC output power.
Serial interface NOTE! The preassigned interfaces have to be switched off beforehand. To do this, click on the corresponding interface in the note that appears.	Select the RS485 interface at which the PIKO MP plus is connected to the KOSTAL Smart Energy Meter.
Timeout	Accept default value.
Maximum output power	It is essential that this value is set for every connected inverter. By selecting the type/inverter power class, the inverter's maximum output power is automatically set. The maximum output power is the maximum output which the inverter being configured is able to deliver.
Battery management	Activate battery support.
Serial interface for battery	Specify the RS485 interface of the KOSTAL Smart Energy Meter to which the communication line of the battery has been connected.
Battery type	Select the battery type, e.g. BYD HVM or BYD HVS.
Number of modules	Select the number of modules that are installed in the battery.
Max. SOC (charging status)	Set the battery's maximum charging status (default 100%).
Min. SOC (charging status)	Set the minimum charging status of the battery. Note the details provided by the battery manufacturer (default 5%).

Parameter	Value
Nominal charging/final charging capacity of battery	This value is set automatically and does not need to be changed. It is calculated by the battery type and the number of modules. However, it can be adjusted if the values do not match the battery.
Open advanced settings	
RS485 address	Enter the inverter's RS485 address. This must be unique for each device and must not already exist.

1. Press the **Save** button to adopt the settings.
- ✓ The PIKO MP plus and battery have been set up in the KOSTAL Smart Energy Meter.

3.4.3 Setting up a new battery with an existing PIKO MP plus

If just one battery is to be set up for an existing PIKO MP plus, this is done via the battery device type.

1. Use the plus symbol to add the battery.

Parameter	Value
Series	Battery
Linking with inverter	Select the PIKO MP plus to which the battery is connected.
Serial interface of battery	Select the RS485 interface at which the battery is connected to the KOSTAL Smart Energy Meter.
Battery type	Select the battery type, e.g. BYD HVM or BYD HVS.
Number of modules	Select the number of modules that are installed in the battery.
Max. SOC (charging status)	Set the battery's maximum charging status (default 100%).
Min. SOC (charging status)	Set the minimum charging status of the battery. Note the details provided by the battery manufacturer (default 5 %).
Nominal charge/discharge capacity of battery	This value is set automatically and does not need to be changed. It is calculated using the battery type and the number of modules. However, it can be adjusted if the values do not match the battery.

1. Press the **OK** button to adopt the settings.
- ✓ The battery has been set up in the KOSTAL Smart Energy Meter and linked to a PIKO MP plus. Finally, the battery still needs to be assigned to the correct DC input in the PIKO MP plus.

INFO

The battery must be assigned to a DC input in the PIKO MP plus. This is done in the PIKO MP plus by going to **Settings > Service > Inputs > DCx > Battery**.

3.5 KSEM with PIKO 4.2-20 / PIKO EPC

The KOSTAL Smart Energy Meter (KSEM) can be used in conjunction with the PIKO 4.2-20 or PIKO EPC in the following variants.

i INFO

It is possible to use the KOSTAL Smart Energy Meter in conjunction with the PIKO 4.2-20 or PIKO EPC as of inverter FW5.0.

- 24-hour load/generation measurement (measuring the current home consumption and output power)
- Multiple-inverter connection (several KOSTAL solar inverters in the same house grid, only one KOSTAL Smart Energy Meter is required for this) **☑ Multiple-inverter connection of KOSTAL inverters, Page 61**
- Dynamic active power control
- Sending measurement data to the KOSTAL Solar Portal

3.5.1 PIKO 4.2-20 / PIKO EPC - load/generation measurement

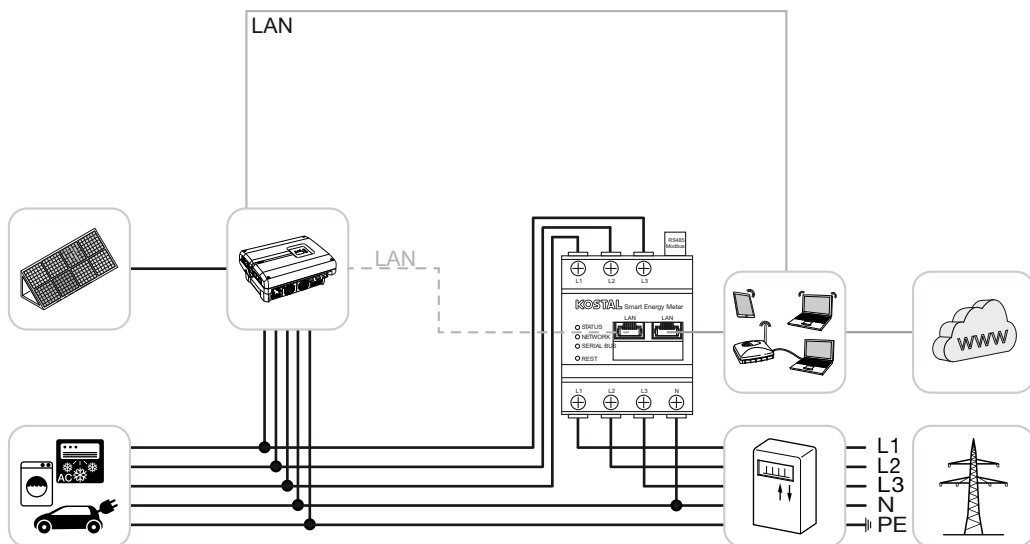

Install KOSTAL Smart Energy Meter at the grid connection point in the house grid as shown.

Set up LAN communication cable between inverter and KOSTAL Smart Energy Meter and connect. As an option, the LAN connection from the inverter can also be connected directly to the KOSTAL Smart Energy Meter (switch function).

In this variant, the KOSTAL Smart Energy Meter runs as a master and controls the inverter (e.g. power limitation).

INFO

For details, see the inverter's operating manual and the KOSTAL Smart Energy Meter's installation instructions.

Set up inverter in KOSTAL Smart Energy Meter. Do this by performing the following steps:

1. Call up online interface of KOSTAL Smart Energy Meter  **Calling up user interface, Page 74**
2. Go to **Inverter > Devices** and use Plus (+) to add the PIKO 4.2-20 or PIKO EPC.

Parameter	Value
Series	Select PIKO FW \geq 5.00
Type	Select inverter
Category	Photovoltaic
IP address	Enter the inverter's IP address.
Maximum output power	Enter the inverter's max. output power. This is required if a power limitation needs to be set and calculated at the grid connection point.
Open advanced settings	
RS485 address	Enter the inverter's RS485 address. This has to be unique for each device (255 by default).

1. Press the **Save** button to adopt the settings.
- ✓ The inverter has been set up.

3.6 KSEM with PIKO CI

The KOSTAL Smart Energy Meter (KSEM) can be used in conjunction with the PIKO CI in the following variants.

- 24-hour load/generation measurement (measuring the current home consumption and output power)
- Multiple-inverter connection (several KOSTAL solar inverters in the same house grid, only one KOSTAL Smart Energy Meter is required for this) **☑ Multiple-inverter connection of KOSTAL inverters, Page 61**
- Dynamic active power control

The KOSTAL Smart Energy Meter can be connected to the PIKO CI in two different ways. The connection method must then be set via the KOSTAL PIKO CI app.

- **☑ PIKO CI - load/generation measurement - connection via LAN, Page 48**
- **☑ PIKO CI - load/generation measurement - connection via RS485, Page 51**

3.6.1 PIKO CI - load/generation measurement - connection via LAN

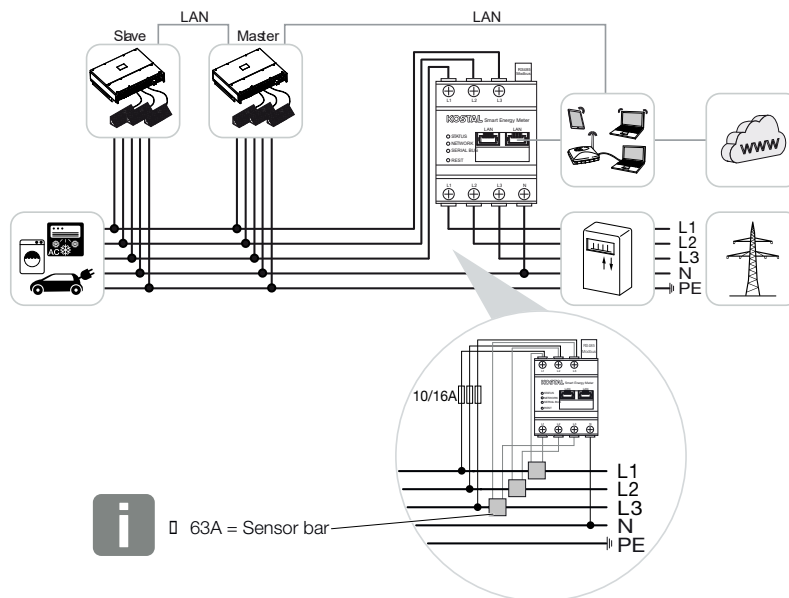

i INFO

For currents above 63A, transformers must be used for measurement on the KOSTAL Smart Energy Meter. Further information on this can be found in the installation instructions for the KOSTAL Smart Energy Meter and at **☑ Menu - device settings, Page 118**.

1. Install the KOSTAL Smart Energy Meter at the grid connection point in the house grid as shown.
2. Set up LAN connection between inverter and KOSTAL Smart Energy Meter and connect.

i INFO

In the KOSTAL CI app for the PIKO CI inverter, the installation position and the use of the KOSTAL Smart Energy Meter in the inverter must be set.

For more information about settings in the inverter, refer to the inverter's operating manual.

3. Establish LAN connection from KOSTAL Smart Energy Meter and inverter to the Internet.

i INFO

For details, see the inverter's operating manual and the KOSTAL Smart Energy Meter's installation instructions.

4. In this variant, the KOSTAL Smart Energy Meter runs as a slave and transmits data to the inverter.
5. In the KOSTAL Smart Energy Meter, you need to go to **Modbus settings > Modbus TCP > Slave (Enable TCP Slave)** and set to **ON**.

Set up the inverter in the KOSTAL Smart Energy Meter. To do this, proceed as follows:

1. Call up online interface of KOSTAL Smart Energy Meter **Calling up user interface, Page 74**
2. Go to **Inverter > Devices** and add the PIKO CI using the plus symbol (+).

Parameter	Value
Series	Select PIKO CI
Type	Select inverter
Category	Photovoltaic
IP address	Enter the inverter's IP address.
Maximum output power	Use the standard maximum output power value for the inverter.
Open advanced settings	
Unit ID	If using Unit ID, the default value 71 should be used.

1. Press the **Save** button to adopt the settings.
- ✓ The inverter has been set up.

3.6.2 PIKO CI - load/generation measurement - connection via RS485

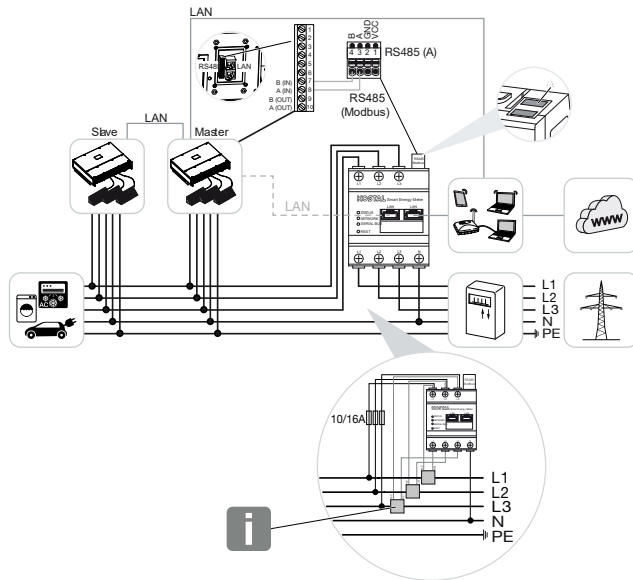

i INFO

For currents above 63A, transformers must be used for measurement on the KOSTAL Smart Energy Meter. Further information on this can be found in the installation instructions for the KOSTAL Smart Energy Meter and at **Menu - device settings, Page 118**.

Install the KOSTAL Smart Energy Meter at the grid connection point in the house grid as shown.

Set up RS485 communication cable between inverter and KOSTAL Smart Energy Meter and connect.

i INFO

In the KOSTAL CI app for the PIKO CI inverter, which you will find in your app store, the terminating resistor for the last inverter must be activated via the software. The installation position and use of the KOSTAL Smart Energy Meter must also be set in the inverter.

For more information about settings in the inverter, refer to the inverter's operating manual.

Establish LAN connection from KOSTAL Smart Energy Meter and inverter to the Internet. As an option, the LAN connection from the inverter can also be connected directly to the KOSTAL Smart Energy Meter (switch function).

i INFO

For details, see the inverter's operating manual and the KOSTAL Smart Energy Meter's installation instructions.

In this variant, the KOSTAL Smart Energy Meter runs as a slave and transmits data to the inverter.

In the KOSTAL Smart Energy Meter, the PIKO CI still has to be selected for the RS485 interface (A). Do this by performing the following steps:

1. Call up online interface of KOSTAL Smart Energy Meter **Calling up user interface, Page 74**
2. Call up Modbus configuration under Modbus settings.
3. Under Modbus RTU, select the **PIKO CI** from drop-down list for RS485 A interface
Press the **Save** button to adopt the settings.

Parameter	Value
Interface	RS485 A
Mode	Slave
Presetting	PIKO CI
Slave address	1
Baud rate	19200
Data bits	8
Parity	None
Stop bit	2

Setting up feed-in limitation

To set up a feed-in limitation (power limitation) at the grid connection point for the public grid, this function has to be set up in the PIKO CI. The KOSTAL Smart Energy Meter cannot control the PIKO CI.

If several PIKO CI are used, the feed-in limitation (power limitation) is configured in the master inverter.

3.7 KSEM with ENECTOR AC 3.7/11 wallbox

The KOSTAL Smart Energy Meter (KSEM) can be used in conjunction with the ENECTOR AC 3.7/11 wallbox in the following variants.

- Blackout protection (house connection monitoring)
Here, the KOSTAL Smart Energy Meter monitors the amount drawn from the grid. If the grid demand exceeds the maximum current (e.g. 63 A per house connection phase) configured in the wallbox, the charging power of the wallbox is reduced to remain below the maximum house connection capacity.
- Use the convenience functions (Lock Mode, Solar Pure Mode, Solar Plus Mode). For more information, see  **Menu – wallbox, Page 79**.

INFO

In order for the wallbox to be set up in the KOSTAL Smart Energy Meter (KSEM), this function must first be activated via an activation code in the KSEM.

The activation code can be purchased from the KOSTAL Solar online shop.

To access the shop, go to: shop.kostal-solar-electric.com.

3.7.1 ENECTOR with KOSTAL Smart Energy Meter for blackout protection (house connection monitoring)

If the ENECTOR is connected to a KOSTAL Smart Energy Meter and this is only to be used for blackout protection (house connection monitoring), the RS485 interface used must be configured in the KOSTAL Smart Energy Meter.

Only then can the ENECTOR read data from the KOSTAL Smart Energy Meter.

Do this by performing the following steps:

1. Call up the online interface of the KOSTAL Smart Energy Meter.
2. Call up the Modbus configuration under **Modbus settings**.
3. Activate the RS485 interface connected to the ENECTOR (e.g. **RS485 B**).
Select the **User-defined** value under **Presettings** and configure the following settings under **Advanced**.

Parameter	Value
Interface	RS485 B
Presetting	User-defined
Mode	Slave

Parameter	Value
Slave address	2
Baud rate	57600
Data bits	8
Parity	None
Stop bit	2

1. Press the **Save** button to adopt the settings.
- ✓ The interface to the ENECTOR has been set up in the KOSTAL Smart Energy Meter.

3.7.2 Setting up ENECTOR with convenience functions in the KSEM

Setting up the wallbox with convenience functions in the KSEM provides a wide range of additional options. With a PV system, functions such as **Solar Pure Mode** or **Solar Plus Mode** are possible. These can be selected as a function via the KSEM interface or using the KOSTAL Solar App. An activation code is required to set up the wallbox in the KSEM.

INFO

In order for the wallbox to be set up in the KOSTAL Smart Energy Meter (KSEM), this function must first be activated via an activation code in the KSEM.

The activation code can be purchased from the KOSTAL Solar online shop.

To access the shop, go to shop.kostal-solar-electric.com.

The following must be done to set up the wallbox with convenience functions in the KSEM:

- Buy activation code from the online KOSTAL shop.
- Enter activation code in the **Activation code** menu. The new **Wallbox** menu then appears.
- Add ENECTOR in the **Wallbox** menu.
- Add KOSTAL inverter in KSEM in the Inverter menu under devices. This sends the inverter data to the Solar Portal.
- Activate data transfer to the KOSTAL Solar Portal in the KSEM.
- Assign the KSEM to a system as a device in the KOSTAL Solar Portal.

Buying activation code from the online KOSTAL shop

1. The link shop.kostal-solar-electric.com will take you to the online KOSTAL Solar shop.
2. You can purchase a code to activate the wallbox in the KSEM under "Activation code".

Entering activation code in KOSTAL Smart Energy Meter

The activation code is entered via the KSEM user interface.

1. Log in to the KSEM on the user interface.
 2. Go to **Activation code**.
 3. Enter and confirm the 10-digit activation code for the wallbox.
- The new **Wallbox** menu appears.
- ✓ Activation is complete.

Enabling RS485 interface

Go to **Modbus settings**. The RS485 interface to which wallbox communication is connected must be deactivated. Only then can the wallbox be assigned to an RS485 interface in the "Wallbox" menu.

Modbus RTU ▼
Settings of serial interfaces

Interface RS485 A

Enable interface

Presetting PLENTICORE / PIKO IQ ▼

Advanced >

Interface RS485 B

Enable interface

Presetting User-defined ▼

Advanced >

RESET SAVE

1. Go to **Modbus settings**.
2. Under **Modbus RTU**, deactivate the RS485 interface (e.g. interface RS485 B) to which wallbox communication is connected.
3. Press the **Save** button to adopt the settings.

Setting up and configuring the wallbox

The points, wallbox connection, selection of functions, current status of the wallbox in relation to the connection and charging/discharging power can be displayed under "Wallbox".

1. The wallbox is set up in the KSEM via **Available charging devices** . To do this, select the **Add** button or the cogwheel on the right.
 2. Give the wallbox a name and select a free RS485 interface (e.g. RS485 B) via which the wallbox is connected to the KSEM.
 3. Save your input.
- ✓ Wallbox is set up.

You can then choose between the different charging modes.

Adding inverters in KOSTAL Smart Energy Meter

To ensure that all data is displayed correctly in the KOSTAL Solar Portal in combination with the wallbox, the KOSTAL inverter must be added under **Inverter > Devices** . Further information can be found in the KOSTAL Smart Energy Meter operating manual.

Activating data transfer to the KOSTAL Solar Portal in the KOSTAL Smart Energy Meter

Data transfer must be activated so that the wallbox data is also visible in the KOSTAL Solar Portal.

1. Go to **Solar Portal**, press the **Activate solar portal** switch.
- ✓ Transfer is activated

INFO

Incorrect time information during data transfer to the KOSTAL Solar Portal

Check the time and time zone set in the KOSTAL Smart Energy Meter and correct them if necessary. If the time is set incorrectly, the data will be transferred from KSEM with incorrect time information and will not be displayed correctly in the KOSTAL Solar Portal.

Assigning the KOSTAL Smart Energy Meter to a system in the KOSTAL Solar Portal

All KOSTAL inverters and the KOSTAL Smart Energy Meter must be assigned to a PV system in the **KOSTAL Solar Portal**. If this was not been done when setting up your PV system, you must do it now.

1. To do this, log in to the **KOSTAL Solar Portal**.
2. Select a system or create a new one.
3. Now add the KOSTAL Smart Energy Meter to this system using the article and serial number. These can be found in the **Solar Portal** menu in the KOSTAL Smart Energy Meter:
 - ✓ The KOSTAL Smart Energy Meter has been set up in the **KOSTAL Solar Portal**. This means that the data can now be accessed in the **KOSTAL Solar Portal** and in the KOSTAL Solar App.

3.8 KSEM with PLENTICORE and ENECTOR AC 3.7/11 wallbox

In conjunction with a PLENTICORE or PLENTICORE BI, the following settings can be used to ensure that wallbox charging is given priority over charging a house battery.

This requires the following settings:

1. Add all inverters as described under **Multiple-inverter connection, Page 61** via IP address by going to **Inverter > Devices** . If using an inverter with battery, ensure the correct category (photovoltaic with battery).
2. Add ENECTOR wallbox as described via activation code in KSEM.
 - If you are using a PLENTICORE with battery and an ENECTOR, the power curtailment (no zero feed-in) can be configured in the inverter.
 - If you have more than one inverter in the system (e.g. a PLENTICORE with battery and a PLENTICORE as PV inverter), set up power curtailment in the KSEM (**multiple-inverter connection, Page 61**) and be aware of the changes to the settling time.

3.9 KSEM with PIKO MP plus and ENECTOR AC 3.7/11 wallbox

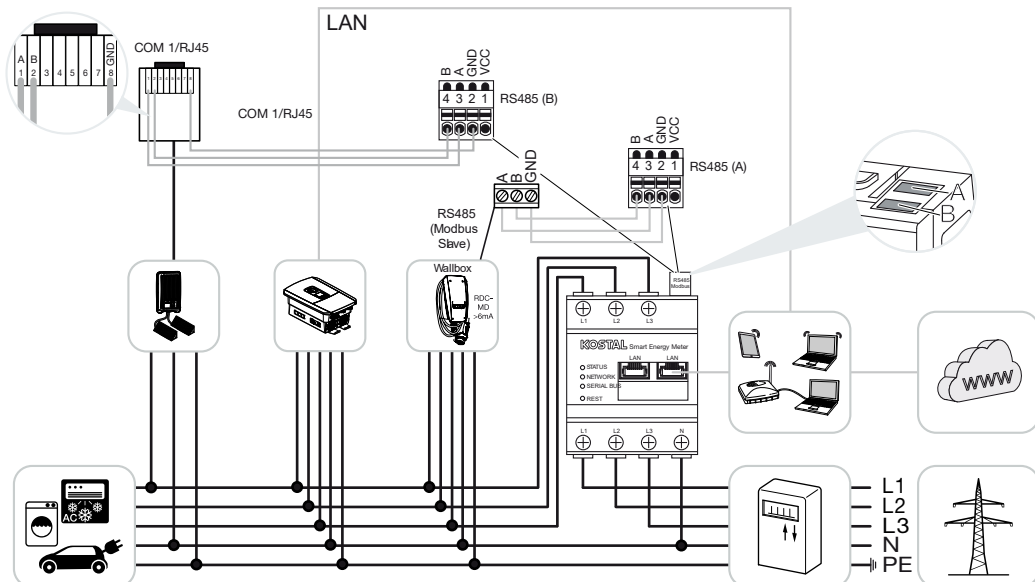

Only one KOSTAL Smart Energy Meter is required to monitor power and limit feed-in at the grid connection point. This is installed at the grid connection point in the house grid as shown in the illustrations.

i INFO

In a device network comprising several KOSTAL inverters, the data is merged in the portal. Correct and complete visualisation can only be found in the KOSTAL Solar Portal and in the KOSTAL Solar App and not in the individual inverter.

To visualize the overall data, the KOSTAL Smart Energy Meter and all KOSTAL inverters must be added in the KOSTAL Solar Portal as devices of a PV system.

If the PIKO MP plus is operated together with the ENECTOR wallbox in a PV system, both communication interfaces are required by the KOSTAL Smart Energy Meter, meaning that no other devices (e.g. PLENTICORE with battery system) can be connected to the KOSTAL Smart Energy Meter.

Please note the following so that the devices are shown correctly in the KOSTAL Solar Portal and/or in the KOSTAL Solar App:

- Install the PIKO MP plus in the house grid (see circuit diagram at the beginning)
- Install KOSTAL Smart Energy Meter at the grid connection point (see circuit diagram at the beginning)
- Install the ENECTOR in the house grid (see circuit diagram at the beginning)

- Connect the PIKO MP plus to the KOSTAL Smart Energy Meter via the RS485 interface.
- No energy meter may be selected for the PIKO MP plus.
- Connect all devices to the KOSTAL Smart Energy Meter and the Internet via LAN
- Activate Modbus protocol in PLENTICORE
- Set up PIKO MP plus in the KOSTAL Smart Energy Meter. It is important that the Modbus RS485 (slave) connection used has previously been enabled in the Modbus settings.
- Set up all KOSTAL inverters in the KOSTAL Smart Energy Meter
- In the KOSTAL Smart Energy Meter, the time zone (e.g. Europe/Berlin) must be selected in the device settings and the time must be set correctly.
- Sending to the Solar Portal must be activated in the KOSTAL Smart Energy Meter and in the inverters.
- Assign all KOSTAL inverters and the KOSTAL Smart Energy Meter to a PV system in the KOSTAL Solar Portal

All devices are then displayed in the Solar Portal.

3.10 Multiple-inverter connection of KOSTAL inverters

With battery storage

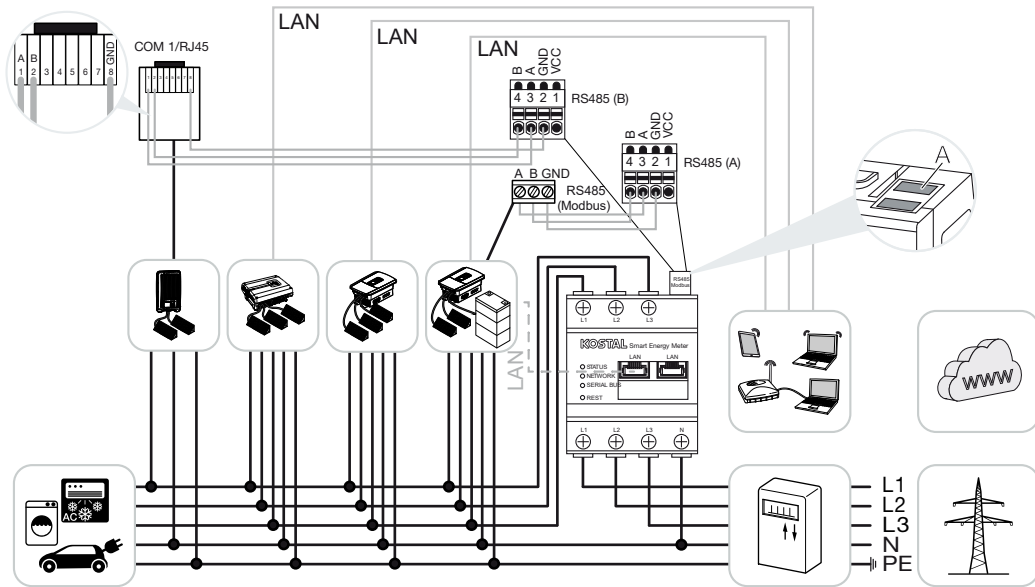

Without battery storage

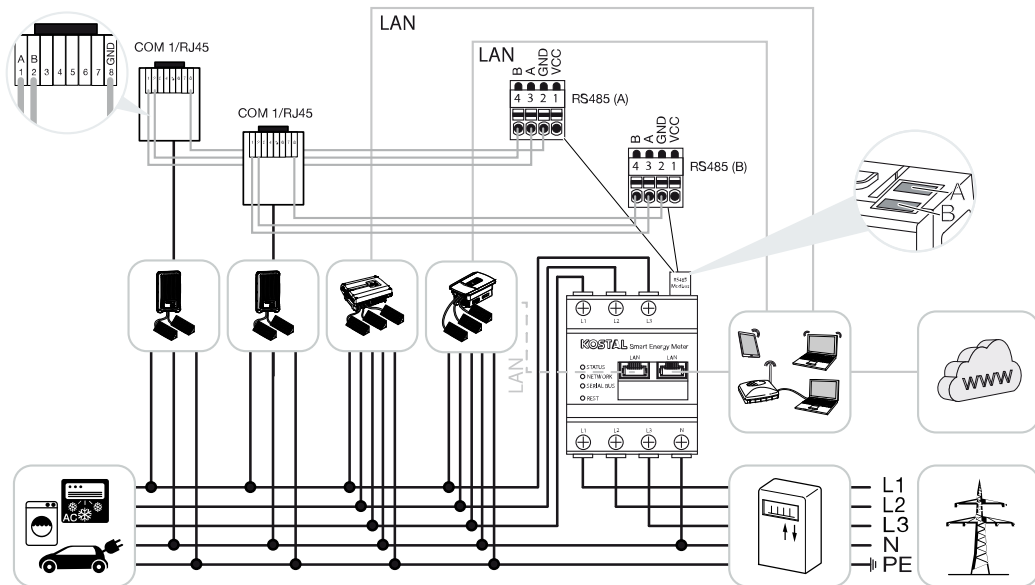

In a multiple-inverter connection, up to 10 KOSTAL inverters can be used in the same house grid.

Only one KOSTAL Smart Energy Meter is required to monitor power and limit feed-in at the grid connection point. This is installed at the grid connection point in the house grid as shown in the illustrations.

i INFO

In a device network comprising several KOSTAL inverters, the data is merged in the portal. Correct and complete visualisation can only be found in the KOSTAL Solar Portal and in the KOSTAL Solar App and not in the individual inverter.

To visualize the overall data, the KOSTAL Smart Energy Meter and all KOSTAL inverters must be added in the KOSTAL Solar Portal as devices of a PV system.

Approved KOSTAL inverters for a multiple-inverter connection with battery storage

In a multiple-inverter connection with battery storage, a maximum of one hybrid/battery inverter (PLENTICORE or PLENTICORE BI) with connected battery may be used.

- 1× PLENTICORE with battery or
- 1× PLENTICORE BI with battery

The following KOSTAL inverters may be used in addition to the hybrid/battery inverter:

- PLENTICORE without battery
- PIKO IQ
- PIKO 4.2-20
- PIKO MP plus
- PIKO EPC
- PIKO CI

Approved KOSTAL inverters for a multiple-inverter connection without battery storage

The following KOSTAL inverters can be used in a multiple-inverter connection without battery storage:

- PLENTICORE without battery
- PIKO IQ
- PIKO 4.2-20
- PIKO MP plus
- PIKO EPC
- PIKO CI

3.10.1 Procedure

The following steps must be taken to set up a multiple-inverter connection with KOSTAL inverters:

- Install all KOSTAL inverters in the house grid (see circuit diagram at the beginning)
- Install KOSTAL Smart Energy Meter at the grid connection point (see circuit diagram at the beginning)
- Connect all devices to the KOSTAL Smart Energy Meter and the Internet via LAN
- If a hybrid/battery inverter with connected battery is being used, also connect this to the KOSTAL Smart Energy Meter via the RS485 interface
- If a PIKO MP plus is being used (only for multiple-inverter connection without battery), also connect this to the KOSTAL Smart Energy Meter via the RS485 interface
- When using a hybrid/battery inverter with connected battery, enable storage of excess AC energy from local generation
- Activate Modbus protocol in PIKO IQ, PLENTICORE
- Configure the settling time in the KOSTAL inverters (see [guide](#))
- Set up all KOSTAL inverters in the KOSTAL Smart Energy Meter
- Set power limitation/feed-in limitation for the grid connection point in the KOSTAL Smart Energy Meter
- Assign all KOSTAL inverters and the KOSTAL Smart Energy Meter to a PV system in the KOSTAL Solar Portal

3.10.2 Communication connection

The following devices must be connected to the KOSTAL Smart Energy Meter and the Internet via a LAN connection.

INFO

For details, see the inverter's operating manual and the KOSTAL Smart Energy Meter's installation instructions.

LAN interface connection:

- PIKO IQ/PLENTICORE/PLENTICORE BI
- PIKO 4.2-20 and PIKO EPC
- PIKO MP plus (the inverter does not have to be configured on the KSEM via LAN, but the inverter must transmit its data to the Solar Portal).
- (only for data transfer to the KOSTAL Solar Portal)

The communication cable between the hybrid/battery inverter and the KOSTAL Smart Energy Meter must be established via the RS485 connection interface (A).

RS485 interface connection (A):

- PLENTICORE BI or PLENTICORE with battery

The communication cable between the PIKO MP plus and the KOSTAL Smart Energy Meter must be established via the RS485 connection interface.

Connection for RS485 interface (B) standard or (A):

- PIKO MP plus

3.10.3 Activating Modbus protocol

Hybrid/battery inverter (PLENTICORE with battery/PLENTICORE BI)

In the Webserver, go to Service menu > Energy management and activate **Storage of excess AC energy from local generation**.

INFO

More information can be found in the inverter's operating manual.

Settings on the inverter are only possible after logging in as an installer.

PIKO IQ/PLENTICORE/PLENTICORE BI

To enable communication between the KOSTAL Smart Energy Meter and the inverter, the Modbus protocol must be activated.

Activate the Modbus (TCP) protocol by going to the following menu item in the Webserver: **Settings > Modbus / SunSpec (TCP) > Activate Modbus**.

INFO

More information can be found in the inverter's operating manual.

The byte order is to be left as standard Modbus (little-endian).

PIKO MP plus/PIKO 4.2-20/PIKO EPC

No further settings are required for the inverters.

3.10.4 Configuring settling time

For the KOSTAL Smart Energy Meter to achieve rapid control with a set feed-in limitation (power limitation) or zero feed-in, the settling time must be configured in the KOSTAL inverters.

This configuration is undertaken as follows:

i INFO

The setting is only needed when using two or more KOSTAL solar inverters and can only be configured by installers using the personal service code.

- For PIKO 4.2-20 and PIKO EPC, using the PARAKO user software

i INFO

More information about the PARAKO parameterisation software for PIKO inverters can be found on our homepage in the download area for your product under operating manual applications.

Communication between inverter and KOSTAL Smart Energy Meter must be disconnected while the software is being used.

- With PIKO IQ, PLENTICORE or PLENTICORE BI via the Webserver

To do this, proceed as follows:

1. In the Webserver, go to Settling time in the Service menu.
 2. In the PARAKO application, call up the settling time by going to **Change settings > Power limitation and reactive power feed-in > Settling time (external control)**.
 3. Set the settling time to 1s.
 4. For external control of active power, select "Power gradient" under mode.
 5. Enter the value 1000 W/s in the specifications for low priority.
 6. Save the settings.
- ✓ The settling time has been set.

3.10.5 Settings in the KOSTAL Smart Energy Meter

RS485 interface

By default, no changes have to be made to the RS485 interfaces. These arrive pre-configured.

The following devices can be connected to the RS485 interfaces:

- RS485 (A): PLENTICORE/PLENTICORE BI
- RS485 (B): PIKO MP plus

If changes are to be made to the settings, perform the following steps:

1. Call up online interface of KOSTAL Smart Energy Meter **Calling up user interface, Page 74**
2. Call up Modbus configuration under Modbus settings.
3. Select **PIKO IQ/PLENTICORE** from drop-down list
Press the **Save** button to adopt the settings.

INFO

When an inverter is selected, the predefined default values are adopted. These can be adapted if necessary.

Parameter	Value
Interface	RS485 A
Mode	Slave
Presetting	PIKO IQ/PLENTICORE
Slave address	1
Baud rate	38400
Data bits	8
Parity	None
Stop bit	2

3.10.6 Adding KOSTAL inverters in the KOSTAL Smart Energy Meter

All KOSTAL inverters in a multiple-inverter connection that are to be measured and controlled using the KOSTAL Smart Energy Meter must be set up in the KOSTAL Smart Energy Meter.

To do this, proceed as follows:

1. Call up online interface of KOSTAL Smart Energy Meter **Calling up user interface, Page 74**
2. Go to **Inverter > Devices** (manage the inverters used).
3. Use the plus symbol to add an inverter.

INFO

When an inverter is selected, the predefined default values are adopted. These can be adapted if necessary.

Parameter	Value
Series	Select series (e.g. PIKO FW >= 5.00, PLENTICORE or PLENTICORE BI)
Type	Select inverter
Category	Choose category (e.g. photovoltaics for PIKO, photovoltaics with battery for PLENTICORE or battery for PLENTICORE BI)
IP address	Enter the inverter's IP address. The IP address can be read on the inverter's display.
Maximum output power	Enter the inverter's max. output power. This is required if a power limitation is to be set and calculated at the grid connection point.
Open advanced settings	
Unit ID	If using Unit ID, the default value 71 should be used.

1. Press the **Save** button to adopt the settings.
 2. Add more inverters using the same function.
- ✓ The inverter has been set up.

INFO

Incorrect time information during data transfer to the KOSTAL Solar Portal

Check the time and time zone set in the KOSTAL Smart Energy Meter and correct them if necessary. If the time is set incorrectly, the data will be transferred from KSEM with incorrect time information and will not be displayed correctly in the KOSTAL Solar Portal.

3.10.7 Setting up devices in the KOSTAL Solar Portal

All KOSTAL inverters and the KOSTAL Smart Energy Meter now simply have to be assigned to a PV system in the KOSTAL Solar Portal.

- To do this, log on to the KOSTAL Solar Portal
- Create a new system
- Now add all KOSTAL inverters that are in the multiple-inverter connection to this system and also the KOSTAL Smart Energy Meter.

For further information, please read the KOSTAL Solar Portal operating manual. You can find them in the download area.

3.10.8 Configuring power curtailment

If power curtailment is to be configured in a multiple-inverter connection, it must be set up in the KOSTAL Smart Energy Meter.

Configuration of the maximum permitted feed-in capacity in the KOSTAL Smart Energy Meter

All inverters must be set up in the KOSTAL Smart Energy Meter via an IP address.

1. Call up the **Plant overview/settings** menu.
2. Click on the gear wheel (**Settings**).
3. Enable **Activate power limitation** switch.
4. Enter the feed-in limit (e.g. 70 %) of the generator output in watts or use the calculator.
5. Click on **Save** to adopt the settings.

INFO

In conjunction with a battery storage system and additional inverters, power curtailment is activated in the KOSTAL Smart Energy Meter. If there is only one PLENTICORE in the system, power curtailment is configured in the inverter.

3.11 Configuring settings in the Webserver

After commissioning, further settings can be configured using the KOSTAL Smart Energy Meter's online interface.

To do this, use your PC or tablet to log in to the KOSTAL Smart Energy Meter. You will find a detailed description in [☑ Operation, Page 70](#).

INFO

To log in, you will need the password from the energy meter's type plate, which can also be found on a separate instruction leaflet in the packaging.

- The following settings should be configured by the installer after the initial commissioning:
- Configure prescribed settings relating to the grid feed-in/power limitation specified by the energy supply company (e.g. for dynamic limitation for PIKO 4.2-20, PIKO EPC and for multiple-inverter connection of solar inverters) if this has not already been done in the inverter.
- Log in to the KOSTAL Solar Portal. In this case, the measurement data is transmitted from the KOSTAL Smart Energy Meter to the portal.

INFO

The installer will need to log in to the KOSTAL Solar Portal for the PIKO MP plus with battery, for KOSTAL solar inverters in a multiple-inverter connection and for the ENECTOR wallbox.

- Set date/time zone
- Update device firmware [☑ Updating device firmware, Page 128](#)
- Change password of KOSTAL Smart Energy Meter. This can be done by going to **Profile > Change password** [☑ Change password, Page 129](#)

4. Operation

4.1	The Webservice.....	72
4.2	Preparing KOSTAL Smart Energy Meter.....	73
4.3	Calling up user interface.....	74
4.4	Configuring settings	76
4.5	The dashboard	77
4.6	Menu - smart meter	78
4.7	Menu – wallbox.....	79
4.7.1	Adding wallbox charging device	79
4.7.2	Charging process status	80
4.7.3	Selecting phase usage	81
4.7.4	Selecting charging mode.....	82
4.7.5	Total charging power	92
4.7.6	Phase load.....	92
4.7.7	Additional settings.....	93
4.7.8	Updating wallbox firmware	94
4.8	Menu – tariff.....	95
4.8.1	Tariff input	96
4.8.2	Managing working prices	97
4.9	Menu - plant overview/settings.....	98
4.9.1	Settings for plant overview	100
4.10	Menu - activation code	102
4.11	Menu - inverter.....	103
4.12	Menu - solar portal.....	109
4.13	Menu - Modbus settings	110
4.13.1	Modbus RTU	111
4.13.2	Modbus TCP	113
4.13.3	Advanced Modbus configuration.....	115
4.13.4	Backup configuration	117
4.14	Menu - device settings.....	118

4.14.1	System information	118
4.14.2	Network settings	119
4.14.3	E-mail settings	120
4.14.4	Internal power meter / transformer	120
4.14.5	Updating firmware.....	121
4.14.6	Serial interface	121
4.14.7	Backup	122
4.14.8	Device.....	122

4.1 The Webserver

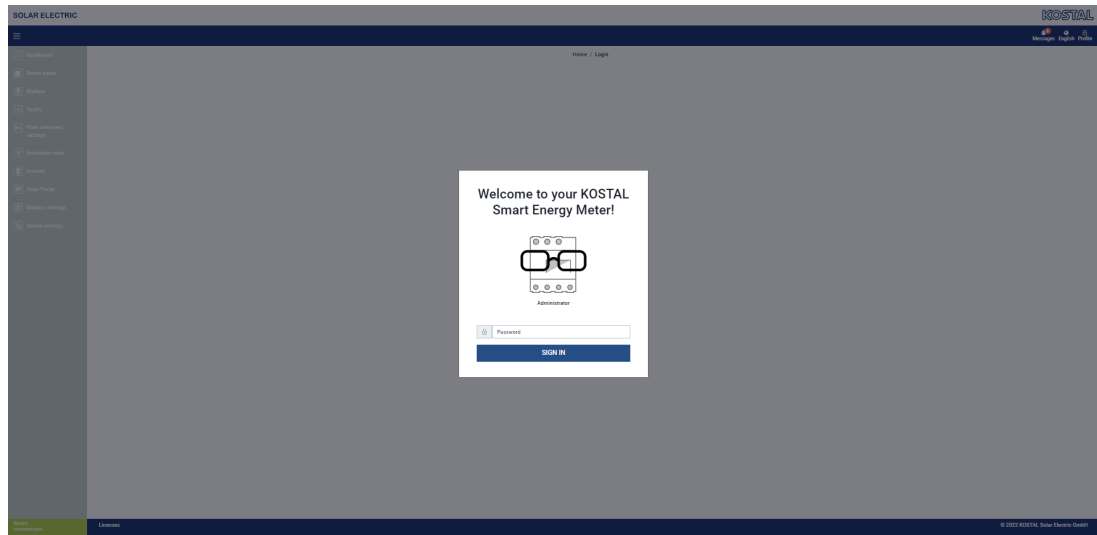

The Webserver forms the graphic interface between the KOSTAL Smart Energy Meter and user.

Go to **Login** to log in to the KOSTAL Smart Energy Meter.

INFO

To log in, you will need the password from the energy meter's type plate, which can be found on a separate instruction leaflet in the packaging.

4.2 Preparing KOSTAL Smart Energy Meter

The KOSTAL Smart Energy Meter has to be connected to an existing local network in order for you to access it.

1. This requires the following steps:
 2. Install the KOSTAL Smart Energy Meter in a distributor box on the top-hat rail according to the installation instructions provided and connect by cable.
 3. Cover KOSTAL Smart Energy Meter with the cover or protection against accidental contact of the sub-distribution in the distributor box.
 4. Connect network cable to KOSTAL Smart Energy Meter's grid connection (LAN port).
 5. Connect the other end of the network cable to a router/switch.
 6. Reconnect sub-distribution to power supply. Wait for the KOSTAL Smart Energy Meter's launch process to end.
- ✓ The KOSTAL Smart Energy Meter is connected to the network.

4.3 Calling up user interface

The user interface is called up using a standard browser on a PC, tablet or mobile phone. To do this, enter host name or IP address of the KOSTAL Smart Energy Meter in your browser's address line. The factory host name is made up of the product name and serial number.

INFO

This function depends on the router settings and may not be available in larger administered networks under some circumstances.

For example: <http://ksem-seriennummer> or <http://ksem-g2-seriennummer>

Calling up online interface via network environment in Windows 10

In Windows, in File Explorer click on **Network** or call up **Devices and printers** via the search function.

INFO

The target network must also not be classified in the PC as a **Public network** otherwise this function will be blocked by Windows.

An icon entitled KOSTAL Smart Energy Meter (e.g. KSEM-712345678) should be visible. Click on the KOSTAL Smart Energy Meter's icon. The standard browser opens with the KOSTAL Smart Energy Meter log-on page.

Using HTTPS in the browser

To use the KOSTAL Smart Energy Meter with HTTPS in the browser, **https://** rather than **http://** must be entered in the address line.

INFO

Because the KOSTAL Smart Energy Meter's online interface is not a website registered on the Internet, the browser will display it as unsafe.

To call up the online interface anyway, the browser's warning must be ignored and a one-off or permanent exception added under **Advanced settings**.

1. Enter the host name or IP address of the KOSTAL Smart Energy Meter in the browser's address line.
2. Press the ENTER key.
→ The login window is opened.
3. Enter the password and press the ENTER key

INFO

To log in, you will need the password from the energy meter's type plate, which can be found on a separate instruction leaflet in the packaging.

- ✓ The KOSTAL Smart Energy Meter's user interface opens.

4.4 Configuring settings

If a PIKO IQ or PLENTICORE is to be connected to the RS485 A interface or a PIKO MP plus is to be connected to the RS485 B interface, no further settings are required because these devices are already preconfigured for these interfaces upon delivery.

If you want to make changes to the settings on the KOSTAL Smart Energy Meter interfaces, you can do this by selecting an inverter for the interface in the Modbus settings. If you are using an ENECTOR AC 3.7/11 wallbox, alternatively you can deactivate the slave interface and use this to activate the wallbox instead. The appropriate values are stored as standard. You can also adapt the values if necessary.

4.5 The dashboard

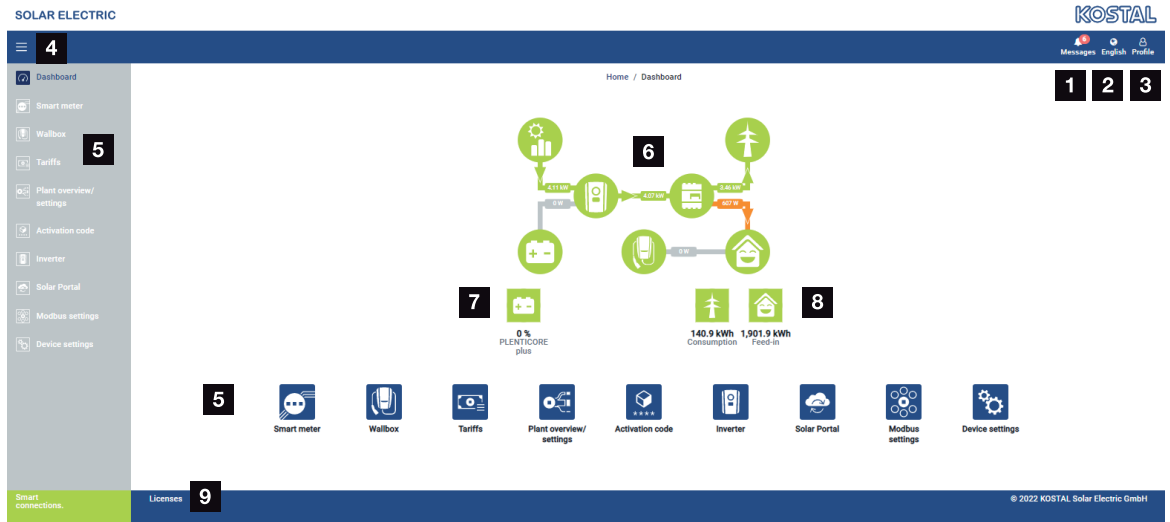

- 1 Messages (e.g. last update)
- 2 Language selection
- 3 Webservice login/logout, change password
- 4 Show/hide menu at side
- 5 Menus
- 6 Energy flow in the house grid
- 7 Current battery SoC
- 8 Current power for consumption and feed-in of the KOSTAL Smart Energy Meter since the device was commissioned.
- 9 Licence information

The dashboard provides the user with an overview of the current most important KOSTAL Smart Energy Meter data.

i INFO

For the energy values to be displayed accurately, the KOSTAL Smart Energy Meter has to be installed at the grid connection point because otherwise not all consumers in the house grid can be recorded.

i INFO

To be able to visualise the correct PV, battery or home consumption power, the inverters must be added under the **Inverter** menu.

4.6 Menu - smart meter

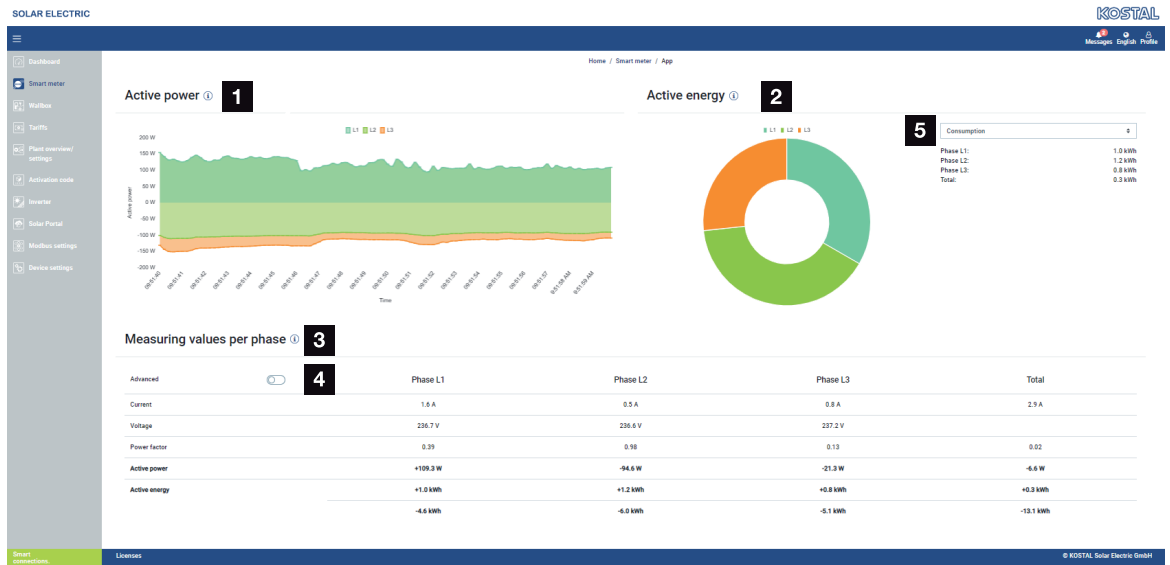

- 1 Active power display (total of all phases)
- 2 Active energy display, shown by consumption or purchase per phase
- 3 Measuring values per phase
- 4 Enhanced mode, measuring values with apparent and reactive power/energy
- 5 Selection of purchase/feed-in

The graphics provide the user with an overview of whether the entire system is purchasing or feeding in power at the present time.

All power and energy values are indicated separately as purchase (+) and feed-in (-).

Active power

The diagram shows totals for the power of the individual phases. The active power (P) is the amount of converted power actually being used by the consumer. It is measured in watts.

Active energy

The diagram and table show the power values for the entire system per phase as a total for consumption or feed-in. The active energy is the power generated over a certain period. It is stated in watt-hours.

Measuring values per phase

The table shows all measuring values recorded by the system per phase. In advanced mode, apparent and reactive power/energy are also displayed.

4.7 Menu – wallbox

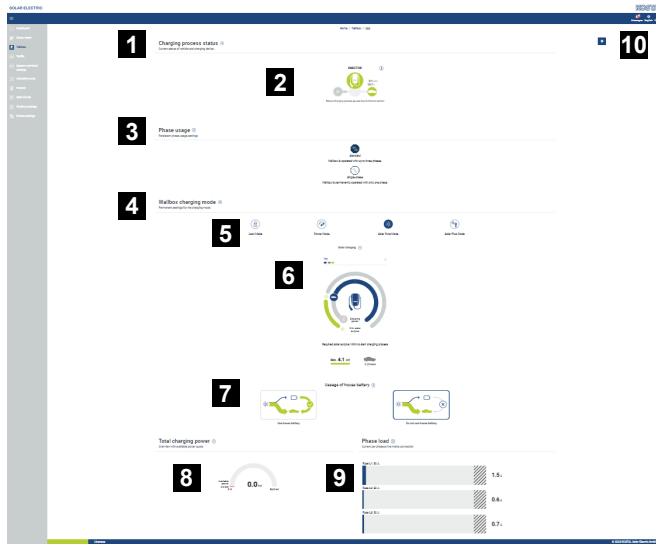

- 1 Overview of the available charging devices and the status of all active charging processes.
- 2 Charging process status. End or start charging.
- 3 Phase usage defines the number of phases that will be used to charge the vehicle.
- 4 Wallbox charging mode defines the conditions in which a charging process should generally be permitted.
- 5 Charging mode selection and settings
- 6 Key for colours/meaning
- 7 Usage of house battery can be selected in Solar Plus Mode. Here you can set whether you generally want to also use the house battery to charge the vehicle or not.
- 8 View showing the power of all charging processes taking place as well as the available power quota over the entire system.
- 9 Current per phase at the mains connection
- 10 Other wallbox settings

The **Wallbox** menu only appears if the function has been activated on the KOSTAL Smart Energy Meter using an activation code **Menu - activation code, Page 102**

4.7.1 Adding wallbox charging device

If there is not yet a charging device present, the first charging device can be set up in the KOSTAL Smart Energy Meter via **Add**.

1. Click on the **Add** button.
2. Give the charging device a name.
3. Select the RS485 interface on the KOSTAL Smart Energy Meter where the wallbox is connected to the KSEM (RS485 B is the default here).

i INFO

Note that the RS485 interface must be enabled in the Modbus settings beforehand.

4. Assign an address (default value 50, no change is necessary).
 5. Click on the **OK** button.
- ✓ The charging device has been added.

4.7.2 Charging process status

This area shows you information about the current charging process. If there is an electric vehicle connected and a charging process is taking place, you can pause or re-start it here. If the charging process is interrupted or paused due to internal control (e.g. cloud hysteresis), this is also shown here.

Charging process status **i**

Current status of vehicle and charging device

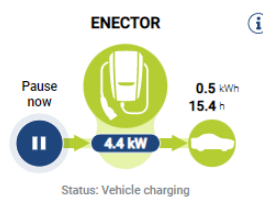

4.7.3 Selecting phase usage

INFO

The menu item is only displayed if SW version 2021.51.9787 or higher is installed on the wallbox.

INFO

The electric vehicle may be damaged when changing over phase usage

It is possible for the wallbox to switch between 1- and 3-phase charging, depending on the power available. This means that the wallbox requests and implements the phase change during an active charging process.

Some vehicles on the market are not compatible with this type of phase change, so, in exceptional cases, this changeover may lead to significant damage in the vehicle during charging. Please check with your vehicle manufacturer whether your vehicle supports this function. Liability for usage errors, installation errors or damage to the vehicle is explicitly excluded.

When the phase is changed over while the charging plug is plugged into the vehicle, the charging process is always terminated before the phase is changed over. The charging process is interrupted for approximately 30 seconds.

If you are unsure whether your vehicle supports this function, unplug the charging plug before changing over the phase. Then, change phases and plug in the charging plug again.

Select the maximum number of phases with which you want to charge your electric vehicle. Three-phase charging is the default setting. However, you can use this setting to charge all electric vehicles, no matter whether you want single-phase, two-phase or three-phase. The electric vehicle determines the maximum charging power.

For three-phase electric vehicles, here you can change the number of phases for charging from three-phase to single-phase charging, which reduces the charging power to 1.4-3.7 kW. This is a good idea if you want to use Solar Pure Mode, for example, and do not have sufficient solar energy available (e.g. during spring or autumn). In this case, the vehicle can be charged with pure solar energy as of a surplus of 1.4 kW.

Phase usage

Persistent phase usage settings



Standard

Wallbox is operated with up to three phases.



Single-phase

Wallbox is permanently operated with only one phase.

- Standard (three-phase)
The three-phase electric vehicle can be charged with a power of between 4.1 - 11 kW.
- Single-phase:
The electric vehicle can be charged with a power of between 1.4 - 3.7 kW.

4.7.4 Selecting charging mode

The charging mode defines the conditions in which a charging process should generally be permitted. You can choose from four charging modes.

Wallbox charging mode

Permanent settings for the charging mode



Lock Mode



Power Mode







Solar Pure Mode



Solar Plus Mode



Time Mode

-  Lock Mode (wallbox locked), Page 82
-  Power Mode (simple charging), Page 83
-  Solar Pure Mode (solar charging), Page 84
-  Solar Plus Mode (solar-optimised charging), Page 86
-  Time Mode (time-controlled charging), Page 89

Lock Mode (wallbox locked)

The wallbox can be locked via the KSEM to prevent access by others. It is not possible to charge an electric vehicle.

On the wallbox, **Lock Mode** is indicated by a rapidly flashing standby LED .

The wallbox can be unlocked by selecting another mode in the KSEM.

Power Mode (simple charging)

In **Power Mode**, the electric vehicle is charged at the maximum charging power. This depends on how the wallbox is connected (single-phase or 3-phase), what maximum charging power has been set in the wallbox, the choice of phase usage and what charging power the electric vehicle allows.

The maximum charging power that the wallbox is to provide is set via DIP switches in the wallbox.

For vehicles that can only be charged 1-phase, the maximum charging power is 3.7 kW.

For vehicles that can be charged 3-phase, the maximum charging power is 11 kW.

Solar Pure Mode (solar charging)

Solar charging is only possible in combination with a PV system and the KOSTAL Smart Energy Meter. The PV system supplies the power needed to charge the electric vehicle. With this function, the electric vehicle is only charged using the PV surplus. If there is a battery in the house network, this can also be used to charge the electric vehicle.

For electric vehicles that are charged 1-phase, the charging power is between 1.4 and 3.7 kW. This means that charging is only started when at least 1.4 kW of surplus PV energy is available and is interrupted or terminated when this falls below 1.4 kW.

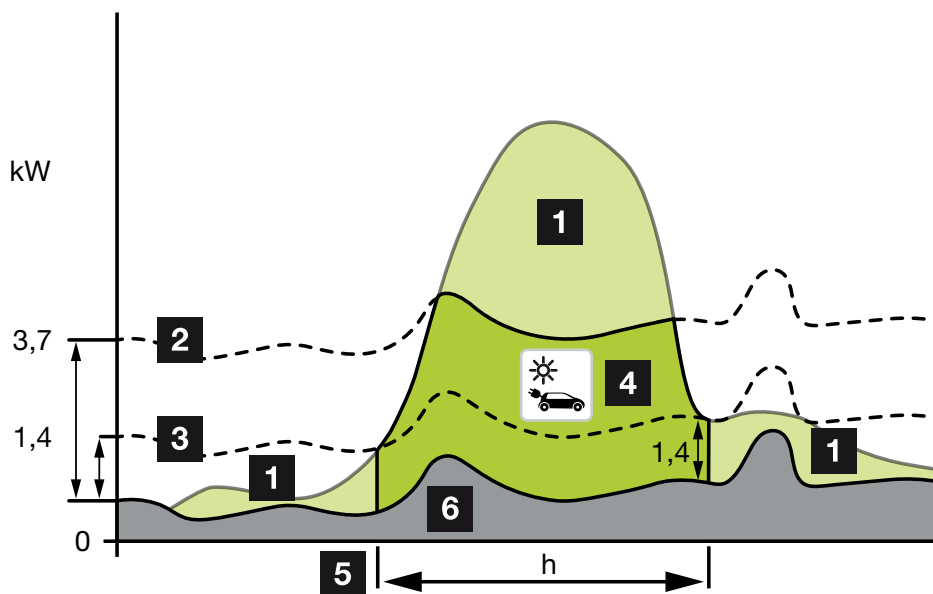

For electric vehicles that are charged 3-phase, the charging power is between 4.1 and 11 kW. This means that charging is only started when at least 4.1 kW of surplus PV energy is available and is interrupted or terminated when this falls below 4.1 kW.

- 1 PV surplus
- 2 Max. wallbox charging power 3.7 kW (with 1-phase vehicle)
Max. wallbox charging power 11 kW (with 3-phase vehicle)
- 3 Min. wallbox charging power 1.4 kW (with 1-phase vehicle)
Min. wallbox charging power 4.1 kW (with 3-phase vehicle)
- 4 Charging electric vehicle with PV surplus
- 5 Electric vehicle charging time
- 6 Home consumption of other devices - partly covered directly from PV.

Usage of house battery

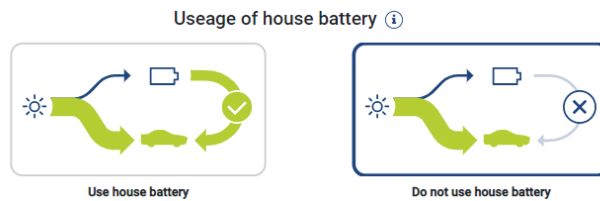

If there is a battery in the house network, this will also be used to charge the electric vehicle as standard.

Use house battery: In this case, the house battery is also used to charge the electric vehicle and the charging process is not interrupted, even if there is too little PV energy available. Should this happen, the charging power is reduced to a minimum. Charging is only stopped if the battery is flat or if the discharge power is no longer sufficient to charge the vehicle.

Do not use house battery: In this case, the house battery is prevented from being used to charge the electric vehicle. The battery is only used for periods with cloud hysteresis/hysteresis for drawing power. The aim is to prevent the charging process from starting and stopping frequently to preserve the electric vehicle's battery.

i INFO

Clouds/hysteresis for drawing power

If the necessary excess power is not available, charging is maintained for approx. 5 minutes at the minimum charging power to avoid unnecessary switching on and off. After the hysteresis time has elapsed, charging is interrupted and only resumed after a wait time of approx. 8 minutes.

Solar Plus Mode (solar-optimised charging)

Solar-optimised charging is only possible in combination with a PV system and the KOSTAL Smart Energy Meter. The PV system supplies the energy needed to charge the electric vehicle.

If there is a PV surplus at the grid interconnection point, the amount drawn from the grid is replaced by the PV power or, if possible, increased to the PV surplus.

If desired, a minimum PV surplus power can also be defined here. This is the minimum level which must be present before charging is started at the power level defined by the customer. If the surplus power falls below the defined minimum value, charging is stopped again.

This function can be used to charge the electric vehicle in the evening, for example, when there is no longer enough PV energy available but the electric vehicle needs to be charged for the next morning.

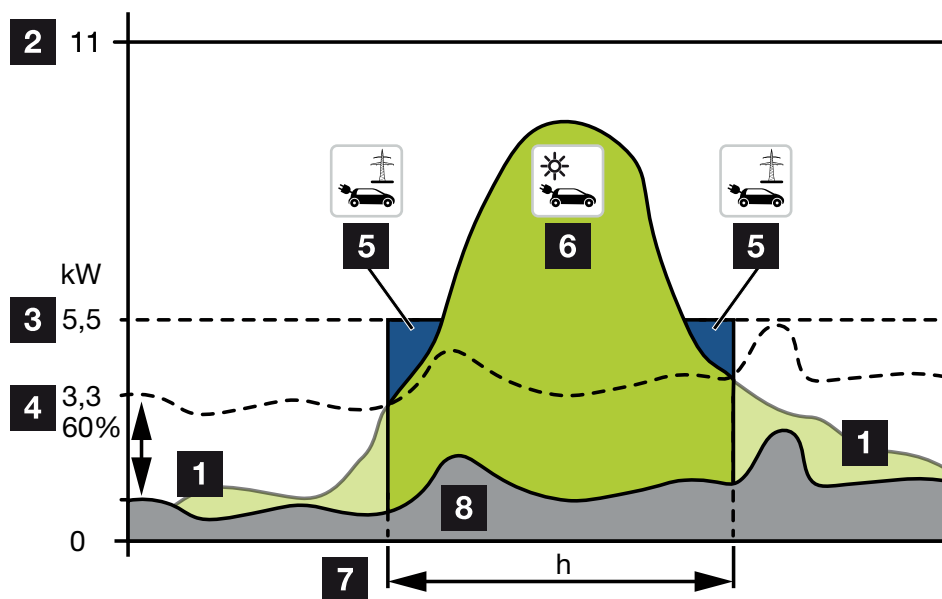

- 1 PV surplus
This surplus can also be used to charge a battery.
- 2 Max. wallbox charging power 11 kW (3-phase).
- 3 Fixed minimum starting charging power.
In this example, at 50% of the max. charging power of 11kW (for 3-phase connection with 3-phase vehicle = 5.5kW).
- 4 Set min. surplus power at the grid connection point before charging is started. In this example, 60 % of 5.5 kW = 3.3 kW.
The additional charging power of 2.2 kW (5) is drawn from the public grid.
- 5 Charging electric vehicle from the public grid. In this example 2.2 kW.

- 6 Charging electric vehicle from PV surplus.
- 7 Electric vehicle charging time.
- 8 Home consumption of other devices - partly covered directly from PV.

Setting the start charging power

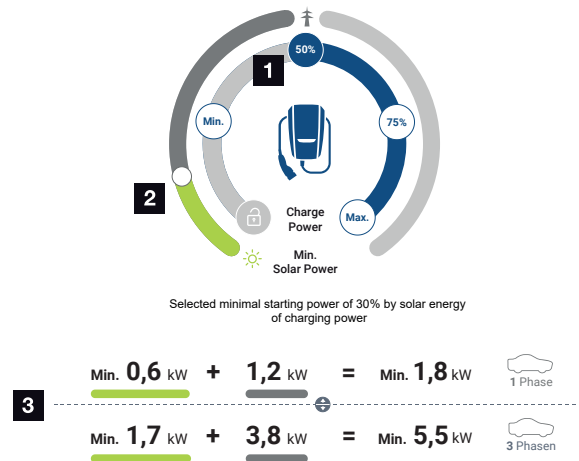

- 1 Set the target start charging power.
- 2 Slider for setting the ratio between solar power used and the amount drawn from the grid in **Solar Plus Mode**.
- 3 Presentation of charging values for electric vehicles.

Target start setting

Min.	The minimum charging power of the connected electric vehicle is determined and set (1-phase 1.4 kW / 3-phase 4.1 kW).
50 %	The charging power is set to 50 % of the maximum charging power of the electric vehicle (1-phase 1.85 kW / 3-phase 5.5 kW).
75 %	The charging power is set to 75 % of the maximum charging power of the electric vehicle (1-phase 2.8 kW / 3-phase 8.25 kW).
Max.	The maximum charging power of the connected electric vehicle is determined and set (1-phase 3.7 kW / 3-phase 11 kW).

INFO

Clouds/hysteresis for drawing power

If the necessary excess power is not available, charging is maintained for approx. 5 minutes at the minimum charging power to avoid unnecessary switching on and off. After the hysteresis time has elapsed, charging is interrupted and only resumed after a wait time of approx. 8 minutes.

Setting the desired minimum share of solar power

In **Solar Plus Mode**, the slider can be used to set the ratio between the solar power used and the amount drawn from the grid.

Lock Mode	Wallbox locked. The slider has no function.
Power Mode	Full charging power from all available sources. The slider has no function.
Solar Pure Mode	100 % of the energy is drawn from the PV system for charging. The slider has no function.
Solar Plus Mode	Set the ratio between solar power and energy drawn from the public grid. Example: If 30 % solar power / 70 % drawn from grid is set, there must be at least 30 % solar power before the charging process is started. The remaining energy is drawn from the grid. If the solar proportion increases, the amount drawn from the grid is reduced.

Display of charging values for 1-phase and 3-phase electric vehicles

The illustration at the bottom shows the setting in kW for 1-phase or 3-phase vehicles. If more solar power is generated than the min. set, the amount drawn from the grid is reduced by the corresponding proportion.

Prioritisation of charging power with connected battery storage (PLENTICORE/PLENTICORE BI)

If a KOSTAL battery system with the PLENTICORE or PLENTICORE BI components is installed in the system, this inverter must be set up via the IP address in the KOSTAL Smart Energy Meter (via Inverter > Devices).

In this case, priority is given to supplying the wallbox with surplus power for the solar modes. The battery storage unit is only charged when the electric vehicle is no longer drawing power.

INFO

When using external storage systems, PIKO BA systems, PIKO MP plus with KOSTAL Smart Energy Meter and battery, fault-free use of the solar modes cannot be guaranteed as different control systems will be controlling the surplus and interfering with each other's control.

Time Mode (time-controlled charging)

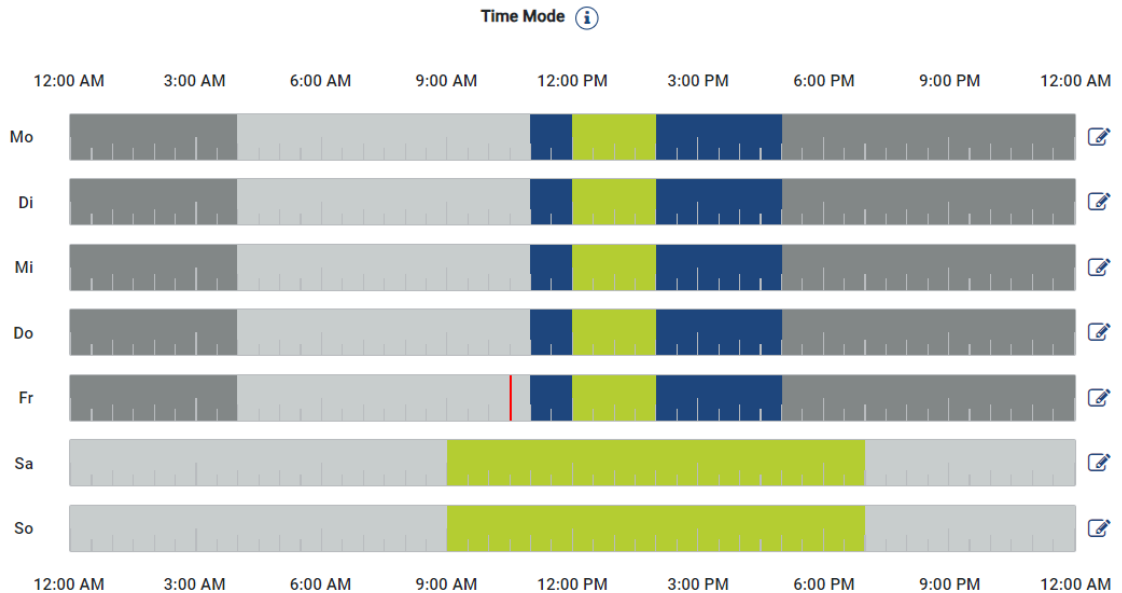

In this mode, you can define the time and the day of the week when one of the available modes is used.

For example, you can lock the wallbox during times when you are generally not present (e.g. between 8 am and midday) (**Lock Mode**) and switch to solar charging (**Solar Pure Mode**) during periods when you plan to be present.

If the vehicle is to be charged at a low power rating (**Solar Plus Mode**) at night or at full charging power (**Power Mode**), this can also be scheduled in.

ⓘ INFO

When **Time Mode** is active, use of the external optional push-button is deactivated so that planned locked periods cannot be cancelled.

Configuring Time Mode

1. Select Time Mode.
2. To edit the day, click on the pencil icon to the right of the timeline. If you want to edit several days at the same time, you can simply highlight them in the editing window.
→ The **Time Mode configuration - Assignment of charging mode** window opens.
3. Start by selecting a mode, e.g. **Solar Pure Mode**.
4. Then select the times when you want this mode to apply, e.g. midday and 1 pm.

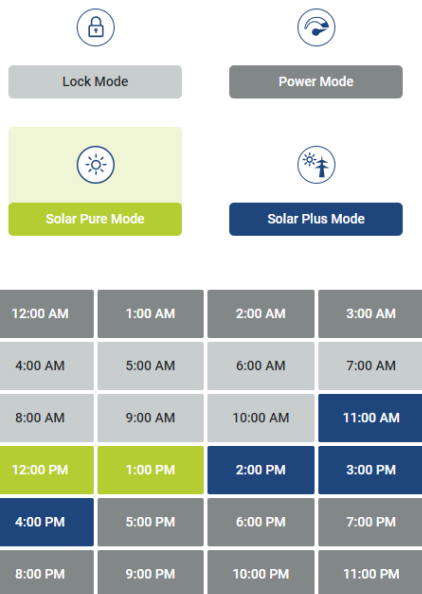

→ The times are marked in the colour that matches the mode.

5. Proceed in the same way for the other times for this day until scheduling is complete.

i INFO

If you select **Solar Plus Mode** here, the charging settings that you have configured under **Solar Plus Mode** are used.

6. You can then use this configuration for the selected day, as well as for other days or all days.

Weekdays

Select the weekdays for which this table of settings is to be used.

Mon	Tue	Wed	Thu	Fri	Sat	Sun	All
<input checked="" type="checkbox"/>	<input type="checkbox"/>	<input type="checkbox"/>	<input type="checkbox"/>	<input type="checkbox"/>	<input type="checkbox"/>	<input type="checkbox"/>	<input type="checkbox"/>

7. To adopt the configuration, click on **Save**.

✓ Time Mode has been set up.

Time Mode is activated once the **Time Mode** icon has been selected. As soon as you select a different mode, **Time Mode** is deactivated.

If you hover your cursor above the timeline, information about the set mode is displayed.

4. Operation

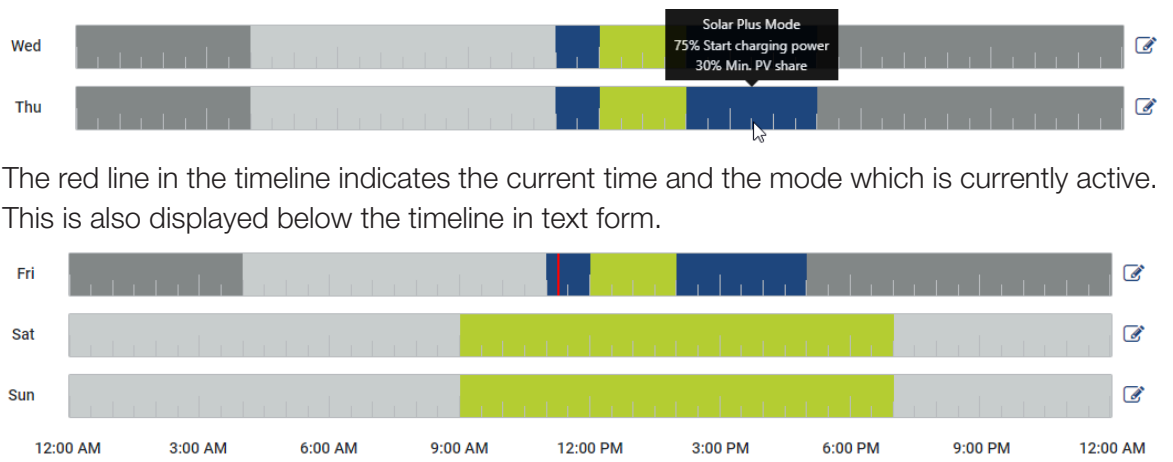

The red line in the timeline indicates the current time and the mode which is currently active. This is also displayed below the timeline in text form.

Current charging mode: Solar Plus Mode
Required solar surplus 30% to start charging process

4.7.5 Total charging power

This is the power of all charging processes taking place as well as the available power quota over the entire system. The maximum power is calculated from the rated current of the main fuse (or sum of the individual main fuses for a poly-phase grid connection). The value for the available power is calculated from the sum of the specified maximum charging currents.

4.7.6 Phase load

This is the current total load per phase (positive and negative) of the grid connection.

If the value exceeds the limit range of the rated current shown (shaded area), the charging current is reduced in order to not overload the grid connection point and thus the house fuse (blackout protection).

4.7.7 Additional settings

The cogwheel (Settings) takes you to the additional setting options.

Available charging devices

This view provides an overview of the charging devices set up as well as their status. You can also add a new charging device or update the wallbox software by going to **Update**  **Updating wallbox firmware, Page 94.**

Actions > Edit can also be used to select the phases used for charging.  **Selecting phase usage, Page 81**

Overload protection

The overload protection prevents the main fuse from tripping at the grid connection. This is configured in the wallbox via DIP switches and displayed here. The settings cannot be changed here.

- With a 3-phase grid connection, the grid connection has three main fuses.
- With a 1-phase grid connection, the grid connection has one main fuse.

The rated current of each fuse can be read off the fuse/circuit breaker in the house connection box.

Advanced settings

Some electric vehicles may experience problems with low charging currents.

The **2011 CP EV out of signaled duty range** ID is output as an event in the KOSTAL Smart Energy Meter.

If this happens, a higher minimum charging current can be selected to remedy the problem.

The problem occurs if a low start charging power (e.g. 6 A) has been set in the wallbox for **Solar Pure Mode** or **Solar Plus Mode** but the electric vehicle needs more power (e.g. 8 A). This results in an error in the wallbox. Increasing the minimum charging current can remedy the problem. However, this also means that all electric vehicles will always start with the increased minimum charging current as long as this setting is activated.

Minimum charging current	Set the minimum charging current per phase from 6 to 16 A. Default value 6 A.
---------------------------------	---

4.7.8 Updating wallbox firmware

i INFO

The menu item is only displayed if SW version 2021.51.9787 or higher is installed on the wallbox.

Going to **Wallbox > Settings (cogwheel) > Available charging devices > Update** allows you to manually update the wallbox firmware using the KOSTAL Smart Energy Meter G2.

The following requirements must be met:

- The wallbox is connected to the KOSTAL Smart Energy Meter via an RS485 connection.
- The convenience functions have been activated for the wallbox in the KOSTAL Smart Energy Meter.
- The wallbox has been set up in the KOSTAL Smart Energy Meter.
- The wallbox must support Modbus version 1.1 (as of wallbox FW: 2021.50.9128-202). The FW version can be accessed by going to **Wallbox > Settings (cogwheel) > Available charging devices > i** (stands for details).

Available charging devices **i**

Overview of the connected charging devices

Label	Type	Address	Phases	Status	Update	Actions
ENEKTOR	KOSTAL ENEKTOR AC 3.7/...	RS485 B - 50	Standard	✓		

Perform the following steps for the firmware update:

1. Download the latest wallbox firmware from our website under **Download > Wallbox > ENEKTOR AC x.x kW > Update**.
2. Go to **Wallbox > Settings (cogwheel) > Available charging devices > Firmware update**.

Available charging devices **i**

Overview of the connected charging devices

Label	Type	Address	Phases	Status	Update	Actions
ENEKTOR	KOSTAL ENEKTOR AC 3.7/...	RS485 B - 50	Standard	✓		

3. Use the **Browse** button to select the file on your PC.
 4. Press **Update** to start the update.
 5. After another question, the new firmware is uploaded and installed on the wallbox.
- Finally, the wallbox is restarted. This process may take several minutes.
- ✓ The firmware on the wallbox has been updated.

4.8 Menu – tariff

Overview

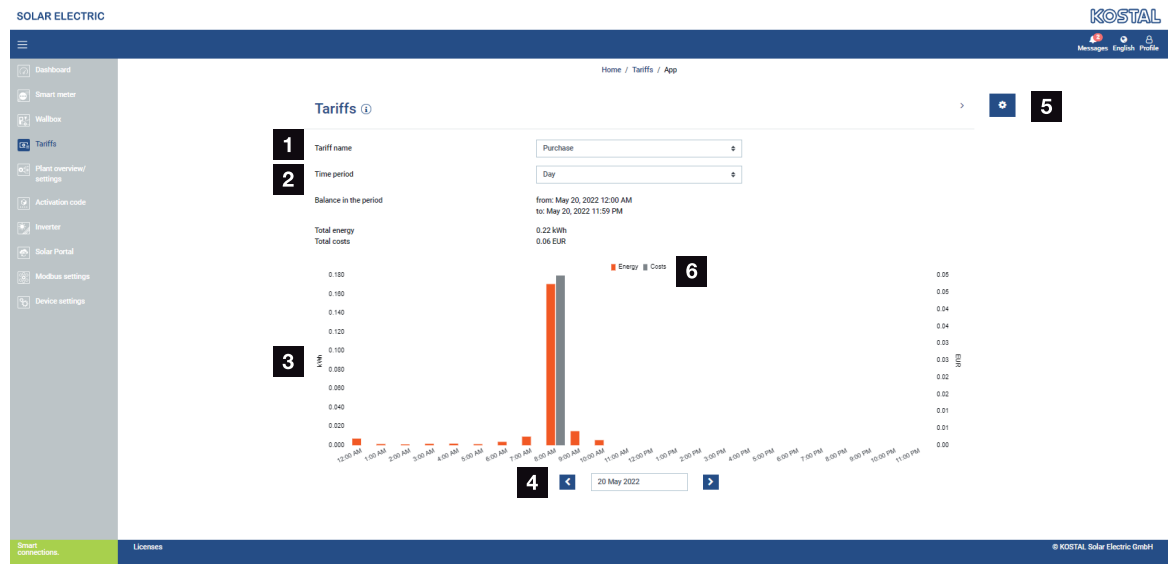

- 1 Switch between viewing feed-in and consumption (purchase)
- 2 Select time period (hour, day, week, month, year)
- 3 Diagram
- 4 Select time period (view depends on choice of time period view)
- 5 Call up tariff settings
- 6 Show and hide the energy/costs by selecting them via the key

Consumption and tariff information for the feed-in and consumption. The tariffs for feed-in and consumption (purchase) are stated under the tariff setting.

i INFO

The diagram also shows the energy in kWh and the costs in the configured currency.

4.8.1 Tariff input

The screenshot displays the 'Settings' page for tariff input in the KOSTAL Solar Electric web interface. The page is titled 'Settings' and includes a sidebar with navigation options. The main content area contains several input fields and buttons:

- 1** Contract information: Currency dropdown set to EUR.
- 2** Monthly basic charge: Text input set to 20, with a unit dropdown set to EUR.
- 3** Device time zone: Dropdown set to Europe/Berlin.
- 4** Tariff name: Dropdown set to Feed-in.
- 5** View of tariff entered: A table showing the tariff rate for each day of the week.
- 6** Edit tariff: A pen icon next to the table.
- 7** Go back to overview: A back arrow and a button labeled 7.

The table below shows the tariff rate for each day of the week:

Day	Rate	Edit
Sun	0.1009	✎
Mon	0.1009	✎
Tue	0.1009	✎
Wed	0.1009	✎
Thu	0.1009	✎
Fri	0.1009	✎
Sat	0.1009	✎

All values in this table are in EUR.

- 1 Select currency
- 2 Enter monthly basic charge
- 3 Select time zone
- 4 Switch between feed-in /consumption tariff
- 5 View of tariff entered
- 6 Edit tariff
- 7 Go back to overview

Here you select the currency and set the monthly basic charge for the tariff. The working price for the tariff for feed-in or consumption (purchase) can be set using the pen symbol next to the tariff view

4.8.2 Managing working prices

- 1 Choice of days for which the tariff is to apply
- 2 Choice of time period for which the tariff is to apply
- 3 Working price (tariff) input
- 4 Create a new working price
- 5 Assign working price to the selected days/hours
- 6 Save settings

Start by entering an energy rate. Several rates can be created for feed-in and consumption. Then select the days and hours for which the working price is to apply and assign these using the **Assign** button. The colours indicate which working price/tariff applies to which time period.

i INFO

If a created working price is not assigned a time window, it is automatically deleted after saving.

4.9 Menu - plant overview/settings

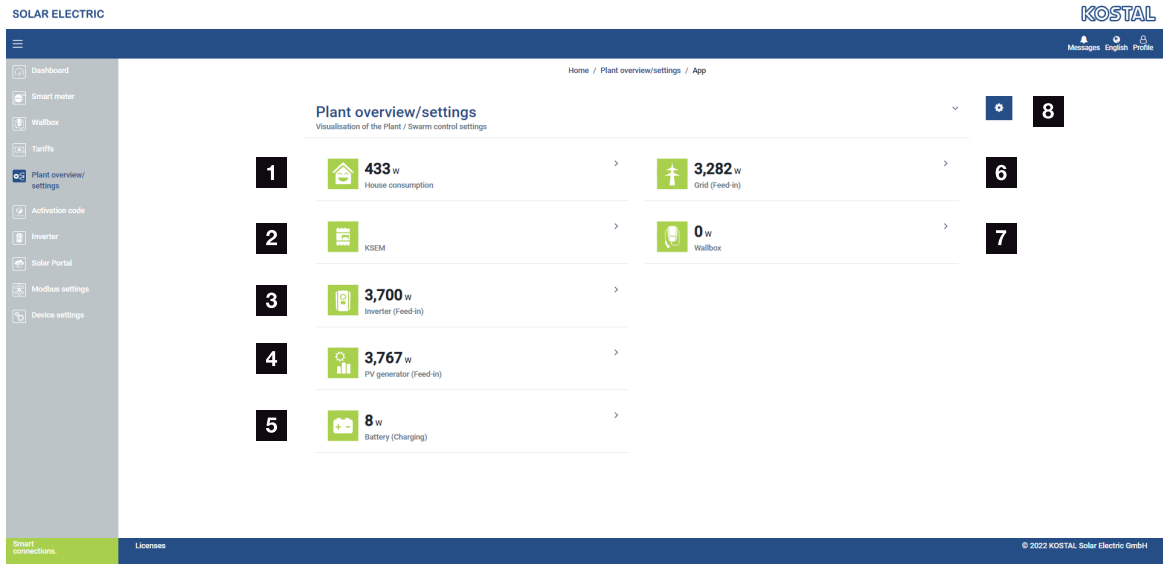

- 1 **House consumption:** Shows the sources from which home consumption is being covered (solar generator [PV], battery or public grid).
- 2 **KSEM:** Shows the curtailment at the grid feed-in point set as an option and the power setpoint if using curtailment by the KSEM. The KSEM must be installed at the grid connection point for this purpose. In addition, all inverters that are controlled via the KSEM must be set up along with their power under **Inverter** in the KSEM so that the calculation is correct.
- 3 **Inverter:** Shows output power and status.
- 4 **PV generator:** Shows the power of the PV generators
- 5 **Battery:** Shows battery power (with battery connected), status and state of charge.
- 6 **Grid:** Shows voltage, current, power per phase and the grid parameters
Feed-in: Energy is fed into the public grid.
Consumption: Energy is purchased from the public grid to cover home consumption.
- 7 **Wallbox:** Status information for the wallbox with performance values
- 8 **Settings:** More setting options for power limitation and diagnosis

i INFO

Incorrect values

For the display to be correct, all inverters must be entered in the inverter menu. **Menu - inverter, Page 103**

Using the various statistics, the user can display the current values for home consumption, KOSTAL Smart Energy Meter, inverter, amount drawn from the grid and wallbox. Detailed information can be displayed by expanding the statistics.

House consumption

Display of the current home consumption and the sources from which home consumption is covered.

Parameter	Explanation
PV	The home consumption is covered by solar power.
Battery	The home consumption is covered by the battery.
Grid	The home consumption is covered by the public grid.

KOSTAL Smart Energy Meter (KSEM)

Parameter	Explanation
Curtailment at the grid feed-in point	In the KOSTAL Smart Energy Meter, an optional power limitation for the entire system can be activated and configured in the settings. The set value is displayed here.

Inverter

Parameter	Explanation
Output power	Output power of the inverter
Status	The inverter's current operational status

PV generator

Parameter	Explanation
PV input power	PV power of the generators

Battery

Parameter	Explanation
Charge/discharge power	Current power when discharging or charging
Status	The battery's current operational status
State of charge	State of charge of a house battery

Grid (consumption)

Parameter	Explanation
Status	Operational status
Grid frequency	Shows the grid frequency
Cos phi	Indicates the current power factor (cos phi)
Phases	Shows the power values per phase

Wallbox

Parameter	Explanation
Serial number	Wallbox serial number
Status	Current operational status of the wallbox
Wallbox status code	Status code for the status
Charging power	Charging power with which the electric vehicle is charged.
Charged energy	Total charged energy that was charged into the electric vehicle during the current charging process.
Charging duration	Current charging duration.

4.9.1 Settings for plant overview

This item can be used as an option to define a feed-in limit for the entire system metered by the KOSTAL Smart Energy Meter when using a multiple-inverter connection.

Parameter	Explanation
<i>Activate power limitation</i>	Here, a set power limitation for an entire system can be activated or deactivated.
<i>Control algorithm used</i>	<p>The control algorithm used can be selected here.</p> <p><i>First generation cluster control</i> Here, the KOSTAL Smart Energy Meter is responsible for controlling the feed-in limitation at the grid connection point. The charge/discharge control of the house battery is handled by the storage/hybrid inverter with connected battery.</p>

Parameter	Explanation
<i>Feed-in capacity limit</i>	<p>The maximum amount which may be fed in by the entire system is entered in the input box. For a simpler calculation, the feed-in capacity limit calculator can be used.</p> <p>The power limitation monitors the feed-in of the entire system. If the value set for the feed-in limit is exceeded, the KOSTAL Smart Energy Meter calculates the amount by which each connected inverter needs to reduce its output to avoid exceeding the feed-in limit. The basis for calculating by how much each individual inverter needs to reduce its power is the value Max. AC output power of inverter, which has been set for the respective inverter.</p> <p>NOTE! For power limitation with several inverters, each connected KOSTAL inverter must be added in the KOSTAL Smart Energy Meter. Third-party inverters or non-selectable devices cannot be controlled via the KOSTAL Smart Energy Meter.</p>

4.10 Menu - activation code

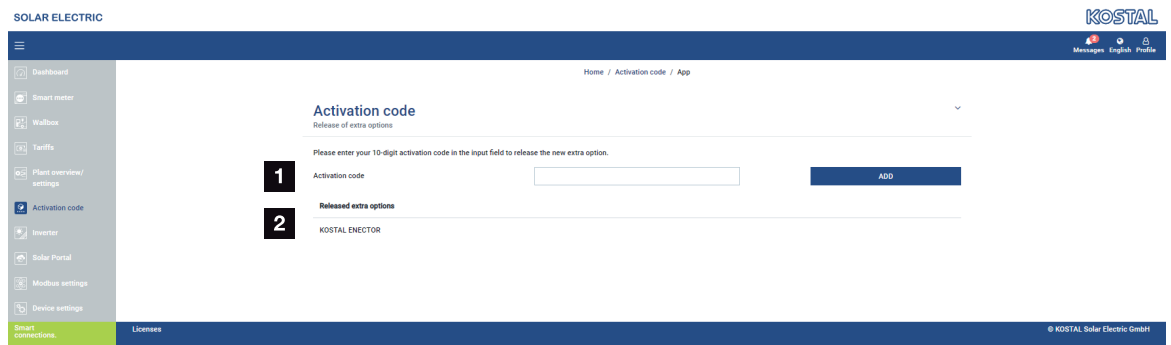

- 1 Activation code entry
- 2 Released extra options

Additional options (e.g. wallbox) can be activated in the KOSTAL Smart Energy Meter (KSEM) via an activation code.

An activation code can be purchased from the KOSTAL Solar Webshop.

To access the shop, go to: shop.kostal-solar-electric.com.

1. Buy activation code from the online KOSTAL shop.
 2. Enter the activation code under **Activation code** and confirm with **Add**.
- The enabled function is displayed.
- ✓ Function activated.

4.11 Menu - inverter

The screenshot displays the 'Inverter' menu in the KOSTAL Solar Electric web interface. The interface is divided into a sidebar and a main content area. The sidebar contains navigation options: Dashboard, Smart meter, Wallbox, Tariffs, Plant overview/settings, Activation code, Inverter, Solar Portal, Modbus settings, and Device settings. The main content area is titled 'Inverter' and contains three sections:

- 1 Status overview**: General status information. A gauge shows 463 W power output and 100% battery level for a PLENTICORE plus inverter.
- 2 Devices**: Manage connected devices. A table lists connected devices.
- 3 Connected devices**: A table with columns: Name, Type, Address, Status. A plus button (+) is visible next to the table header for adding new devices.
- 4**: Option for configuring connected devices (indicated by a plus button in the table).

- 1 Inverter status overview
Battery status overview (only for PIKO MP plus with battery)
- 2 Overview of the connected devices
- 3 Connected devices
- 4 Option for configuring connected devices

The KOSTAL Smart Energy Meter is linked to the KOSTAL solar inverters to reduce the feed-in capacity of inverters, if required, or to control the battery when using the PIKO MP plus.

In addition to this, the KOSTAL Smart Energy Meter can be connected to the KOSTAL Solar Portal to transfer data from the KOSTAL Smart Energy Meter and inverter to the portal.

Status overview

Shows general information about the devices.

Devices

Shows all connected inverters or batteries linked to the PIKO MP plus.

New devices can be added using the Plus (+) button. The type of communication (TCP or RS485) used between the inverter and KOSTAL Smart Energy Meter is determined by the choice of inverter (e.g. PIKO IQ or PIKO MP plus).

If the "Battery management" function is selected in addition to the PIKO MP plus, the communication interface to the battery and a depth of discharge (SoC) can be selected.

INFO

“Battery management” is only displayed if the additional battery option has been activated for the PIKO MP plus using an activation code.

Different parameters have to be configured depending on the device type. If all relevant settings have been configured, detection of the inverter can be started by pressing the **OK** button.

INFO

Only then is a device added to the KOSTAL Smart Energy Meter if the inverter was detected successfully.

Parameter	Explanation
<p>PIKO MP plus</p> <p>NOTE! Here the PIKO MP plus only has to be set up for a multiple-inverter connection or when using a battery system.</p>	<p>A PIKO MP plus inverter is to be set up.</p> <p>Select the corresponding type or power class of the inverter. This automatically sets the maximum AC output power of the inverter.</p> <p>This type of inverter communicates using the RS485 interface. To connect the inverter, you will need to state the RS485 interface of the KOSTAL Smart Energy Meter to which the inverter was connected.</p> <p>If there are several inverters, different RS485 addresses should be used.</p> <p>The value for “Timeout” does not need to be changed. For more information, see “Timeout” on the next pages.</p> <p>Battery management:</p> <p>NOTE! “Battery management” is only displayed if the additional battery option has been activated for the PIKO MP plus using an activation code. If a battery is set up using this item, it is automatically connected to the inverter once confirmed.</p> <p>If a battery is to be set up for the PIKO MP plus, you can activate battery support for this here.</p> <p>You should then select the communication interface (RS485) of the KSEM to which the battery’s communication cable is connected.</p> <p>For more information about the settings, see “Battery” on the next pages.</p>
<p>PLENTICORE PIKO IQ PLENTICORE BI</p> <p>NOTE! The inverter only needs to be set up if you would like visualisation via the dashboard or if used in conjunction with an EN-ECTOR or a multiple-inverter connection.</p>	<p>A PIKO IQ, PLENTICORE or PLENTICORE BI inverter is to be set up.</p> <p>Select the type or power class of the inverter. This automatically sets the maximum AC output power of the inverter.</p> <p>This inverter communicates using TCP. The IP address has to be stated for the connection.</p> <p>The unit ID does not have to be changed.</p> <p>With a PLENTICORE, you must also select whether you have connected a battery to the inverter so that this value is taken into account in the calculations/displays.</p>

Parameter	Explanation
PIKO FW >= 5.0	<p>A PIKO 3.0-20 or PIKO 36 EPC inverter is to be set up.</p> <p>Select the corresponding type or power class of the inverter. This automatically sets the maximum AC output power of the inverter.</p> <p>This type of inverter communicates using TCP (LAN). The IP address has to be stated for the connection.</p>
PIKO CI	<p>A PIKO CI inverter is to be set up.</p> <p>Select the corresponding type or power class of the inverter. This automatically sets the maximum AC output power of the inverter.</p> <p>This type of inverter communicates using TCP (LAN). The IP address has to be stated for the connection.</p>

Parameter	Explanation
Battery	<p>A battery is to be set up for a set-up PIKO MP plus.</p> <p>Linking with inverter</p> <p>Select the inverter to which the battery is connected. This must be set up beforehand so that it is displayed here.</p> <p>Serial interface</p> <p>The battery communicates using the RS485 interface. To connect the battery, you will need to specify which RS485 interface of the KOSTAL Smart Energy Meter the battery's communication cable was connected to.</p> <p>Battery type</p> <p>Select the battery type, e.g. BYD HVM or BYD HVS.</p> <p>Number of modules</p> <p>Select the number of modules installed in the battery.</p> <p>Max. SOC (charging status)</p> <p>The battery's maximum charging status must be set here (default 100 %).</p> <p>Min. SOC (charging status)</p> <p>The minimum charging status of the battery must be set here. Note the details provided by the battery manufacturer (default 5 %).</p> <p>Nominal charge/discharge capacity of battery</p> <p>This value is set automatically and does not need to be changed. It is calculated using the battery type and the number of modules. However, it can be adjusted if the values do not match the battery.</p>
Timeout	<p>This value in seconds indicates the time after which an error message is output in the event of a fault in communication with the configured device.</p>

Parameter	Explanation
Maximum output power	<p>It is essential that this value is set for every connected inverter.</p> <p>By selecting the inverter's type or power class, the inverter's maximum output power is automatically set.</p> <p>The maximum output power is the maximum output which the inverter being configured is able to deliver.</p> <p>The value for the max. output power only depends on the inverter type and design. The actual capacity of the connected solar modules is not relevant for this setting.</p>

Explanation of device overview

Parameter	Explanation
Name	<p>Shows the name which the user has given to the KOSTAL solar inverter.</p> <p>The name is assigned via the inverter menu interface.</p>
Type	Shows the type designation of the inverter/battery.
Address	Either the IP address or RS485 address of the inverter is shown.
Status	<p>Status display of communication to the inverter. Two different statuses are possible:</p> <p>OK (✓) indicates that communication with the inverter is working normally.</p> <p>Error (!) means that communication with the inverter is interrupted.</p>
Info (i)	<p>Additional information, such as serial number, hardware and software versions, can be retrieved via the Info symbol.</p> <p>OK (✓) indicates that communication with the inverter is working normally.</p> <p>Other values are an error code.</p>
Edit (pen symbol)	The “edit symbol” (pen symbol) can be used to modify the configuration of a connected inverter/battery. Changes only take effect once they have been confirmed with OK .
Delete (bin symbol)	An inverter can be deleted from the KOSTAL Smart Energy Meter using the bin symbol.

4.12 Menu - solar portal

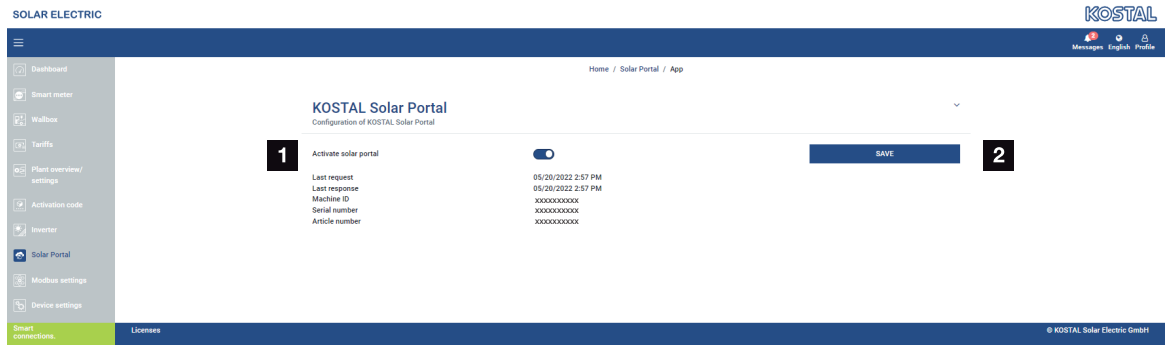

- 1 Activate data transfer to the solar portal.
- 2 Save change.

The connection to the solar portal can be activated or deactivated in the Solar Portal menu. Information about the connection status is also displayed.

i INFO

In order for the data in the solar portal to display the correct time values, it is important that the correct time zone and time are selected in the KOSTAL Smart Energy Meter under **Device settings > Device > Date and time**.

The connection to the KOSTAL Solar Portal is only made or broken after clicking on the **Save** button.

i INFO

In the solar portal, the article and serial number of the KOSTAL Smart Energy Meter must be entered for registration.

Parameter	Explanation
Last request	Time of last query to the solar portal. A “-” means that there haven't been any queries yet.
Last response	Time of portal's last response.
Machine ID	An ID issued for the KOSTAL Smart Energy Meter by the solar portal.
Serial number	Serial number of the KOSTAL Smart Energy Meter
Article number	Article number of the KOSTAL Smart Energy Meter.
Activate solar portal	Activate or deactivate connection/transfer to the solar portal.

4.13 Menu - Modbus settings



- 1 Set up the Modbus RTU (RS485) interface
By default, the RS485 A interface is pre-configured for the PIKO IQ/PLENTICORE and the RS485 B interface for the PIKO MP plus.
- 2 Set up the Modbus TCP interface
- 3 Dynamic Modbus mapping overview
- 4 Advanced Modbus configuration
- 5 Download/restore the Modbus configuration

Select the devices which are connected to the RS485 Modbus RTU interfaces or activate the Modbus TCP functionality if the devices use the Ethernet (LAN) for communication purposes. In this case, Modbus TCP communication must also be activated in the inverter. The TCP functionality must only be activated if the KOSTAL Smart Energy Meter is to be queried by an external device via Modbus TCP (Modbus TCP slave).

i INFO

If you want to use an ENECTOR wallbox with enabled convenience functions or a PIKO MP plus with connected battery, the RS485 interface (e.g. RS485 B) must be enabled here.

i INFO

You will find a detailed description of the Modbus protocol and how it works in the Modbus specification (e.g. see www.modbus.org). Modbus TCP is part of the IEC 61158 standard.

4.13.1 Modbus RTU

KOSTAL solar inverters, but also other devices, can be connected to the Modbus RTU RS485 interface.

In **Modbus RTU Slave** mode, the KOSTAL Smart Energy Meter provides the measurement data via the RS485 interface. However, in **Modbus RTU Master** mode, measurement data is sent and written to other slave devices in order to control them. Master mode is only possible via user-defined settings.

Both RS485 interfaces A and B can be configured individually.

i INFO

You will find details of how to connect the communication cable from the inverter to the RS485 socket in the KOSTAL Smart Energy Meter's installation instructions.

Depending on the cable length and number of participants on the bus, we would recommend terminating the bus at both ends with a 120-ohm resistor. Termination reduces reflections in the connection. Under certain circumstances, this may be absolutely essential for application reliability.

When an inverter is selected for RS485 interface A or B, all fields are populated with pre-defined values. These can be adapted if necessary.

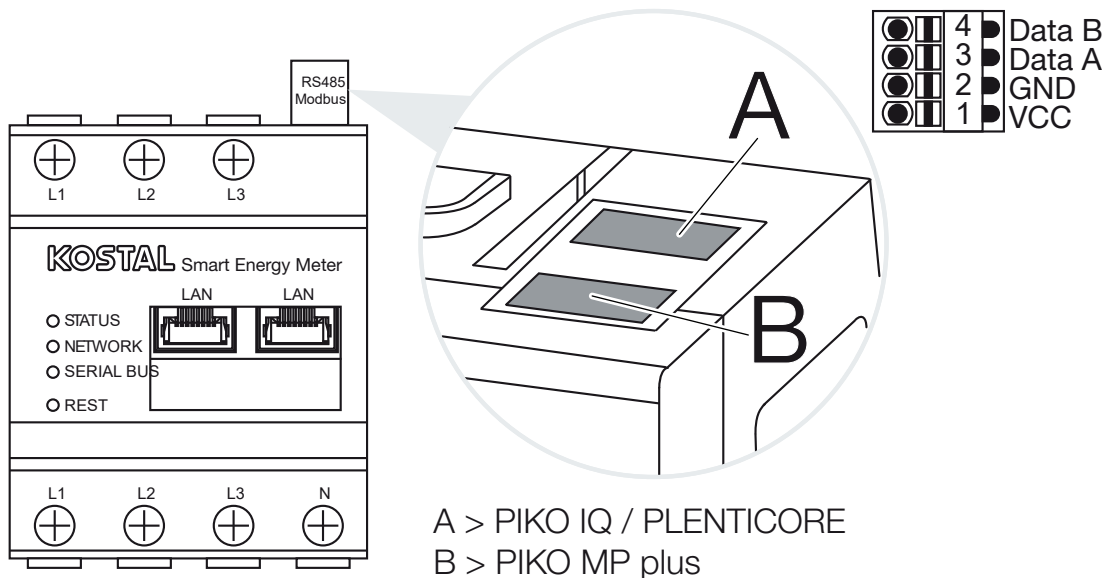

Settings for Modbus RTU via RS485

Parameter	Explanation
Interface	<p>RS485 (A) Pre-configured for PIKO IQ/PLENTICORE</p> <p>RS485 (B) Pre-configured for PIKO MP plus</p>
Enable interface	<p>Activated The Modbus - slave functionality on the respective RS485 interface is activated. Data can only be retrieved from the KOSTAL Smart Energy Meter via the interface once the interface has been activated and the settings have been saved.</p> <p>Deactivated The Modbus interface is deactivated.</p> <p>NOTE! When using a PIKO MP plus with a connected battery or an ENECTOR wallbox and enabled convenience functions, you will need to deactivate the interface here. You are asked to do this when setting up the battery or the wallbox in the setup menu for the devices.</p>
Presetting	Selection of connected device. When a device is selected, all fields are populated with predefined values. These can be adapted if necessary.
Mode	<p>Slave (default)/master The interface operates either as a Modbus master (data is sent and written to slave devices) or as a Modbus slave (only data which can be accessed from other devices is made available).</p>
Slave address	<p>Defines the address of the Energy Manager in the Modbus</p> <p>The value may be between 1 and 247.</p>
Baud rate	Defines the baud rate of the connection
Data bits	Defines the number of data bits
Parity	Defines the parity of the connection
Stop bits	Defines the number of stop bits

4.13.2 Modbus TCP

Other devices that evaluate the data of the KOSTAL Smart Energy Meter can be connected to the Modbus TCP (LAN) interface.

“Master” mode

In the operating mode **Modbus TCP > Master**, the KOSTAL Smart Energy Meter writes to the registers of one or more connected devices acting as Modbus slaves. These devices may be SPS controllers or external energy management systems with standardised Modbus connections, for example, but they do not only have to be hardware specifically suited to this purpose. Web services, for example, can also receive data using this mode. However, the devices do have to be configured specifically to receive these register ranges.

It is possible to write to both the internal device power register and energy value register. You can also decide whether to transfer the sum value of all three phases only or the individual values. The relevant register ranges can be switched on and off in the tab **Advanced Modbus configuration > Register configuration**.

The KSEM/RM PnP registers and the SunSpec registers are not transmitted via the Modbus TCP master. You will find information about the respective registers in the **KOSTAL Smart Energy Meter– Interface Description Modbus** documentation in the download area for the KOSTAL Smart Energy Meter.

In **Master** mode, the KOSTAL Smart Energy Meter sends and writes information to the registers of the configured slaves. These are added by entering the slave IP address.

Parameter	Explanation
Slave address	Defines the address of a TCP slave. This can be specified in the form of an IP address or URL.
Port	Defines the TCP port on which the slave expects Modbus communication.
x	Deletes the line
Add	Adds a line

Up to 10 TCP slaves can be configured.

“Slave” mode

In **Slave** mode, the KOSTAL Smart Energy Meter provides its measurement data (Modbus register) via LAN interface (TCP/IP). This setting is used to ensure that the KSEM can be read by third parties.

The Modbus **Slave** can be reached at port number 502 as standard. Port number 802 must be used for encrypted connections.

Some writeable Modbus registers enable a wallbox that is controlled by the KOSTAL Smart Energy Meter to be controlled externally. Please be aware that the connection must be converted from Modbus TCP via port 502 to Modbus TCP with TLS encryption via port 802. This applies to all connections in this case.

Parameter	Explanation
Enable TCP Slave	<p>Enabled</p> <p>The Modbus slave functionality on the Ethernet interface (LAN) is enabled. Data can only be retrieved from the KOSTAL Smart Energy Meter via the interface once the interface has been activated and the settings have been saved.</p> <p>The Modbus slave can be reached at port number 502 as standard.</p> <p>Deactivated</p> <p>The Modbus interface is deactivated.</p>
Enable encryption (TLS)	<p>Enabled</p> <p>Enables encryption using TLS for Modbus slave connections. If encryption is enabled, the Modbus slave can only be reached via port number 802.</p> <p>Deactivated</p> <p>Encryption is deactivated.</p>

Certificates

Dealing with self-signed TLS certificates

A TLS certificate and the associated private key are required to set up an encrypted Modbus TCP connection. In the most simple cases, this type of key pair can be generated using the program **openssl**. This is a self-signed certificate. TLS versions below Version 1.2 are not supported.

INFO

Tapping sensitive data

Unknown TLS certificates should always be carefully checked to prevent unauthorised access to measurement data on the device by third parties.

For receivers that use known certificates or certificates that are already accepted, a secure TLS connection is automatically established.

The device has a range of trustworthy certificates and certification authorities (CA). If a connection is being established with a receiver for the first time and this receiver has a self-signed certificate, the device detects the certificate and the user must actively accept it. All read and write access to the Modbus registers is refused until this is confirmed.

An overview of added and unknown certificates is provided in the **Certificates** drop-down table, which is located right below the Modbus TCP configuration. Certificates are described there as follows:

Status: Accepted

- The status displays a green tick. This certificate is trusted by the device. The certificate can be removed from the device by going to **Delete**.
- Receivers that use this certificate are trusted and a secure TLS connection can be established to them.
- Clicking on **Delete** will delete the certificate from the list of trusted certificates. This certificate is no longer trusted and open connections using this certificate are terminated immediately.

Status: Not accepted

- The status displays a red cross. There is an **Accept** button behind it. This certificate is not trusted.
- In order to establish a secure TLS connection to receivers using this certificate, this certificate must first be actively trusted.
- Clicking on **Accept** adds the certificate to the trusted certificates and it is then considered to be accepted. A secure TLS connection can now be established from receivers that use this certificate.

4.13.3 Advanced Modbus configuration

Here, further settings can be selected for the Modbus master functionality. These settings apply to all configured Modbus masters.

Transmit interval

Here, you can set an interval, at which the measurement data is to be transmitted from the KOSTAL Smart Energy Meter. The Energy Manager usually transmits its measurement data via the Modbus master as soon as it is available. If the interval is activated, the data is transmitted at a regular interval instead, regardless of when it is available. Only the current measuring values at the transmit time are ever communicated. Mean values are not produced for the interval.

Parameter	Explanation
Enable fixed transmit interval	<p>Activated KOSTAL Smart Energy Meter data is transmitted at a fixed transmit interval. Selection of interval from drop-down menu.</p> <p>Deactivated KOSTAL Smart Energy Meter data is transmitted after each measurement cycle (200ms or 500ms).</p>
Set transmit interval	Select a transmit interval using the drop-down menu or enter a user-defined transmit interval in seconds at which you want the KOSTAL Smart Energy Meter to send its data.
Averaging over transmit interval	<p>Averaging over transmit interval switches on averaging calculations for the transmit interval.</p> <p>Activated Calculates and transmits a mean value for all measurement cycles within the set transmit interval.</p> <p>Deactivated Transfer current measuring values at the end of the transmit interval.</p>

Register configuration

Groups of registers can be selected here, which are to be written in master mode. The system load of the KOSTAL Smart Energy Meter can therefore be reduced if all of the registers are not required. This may be necessary if lots of devices are connected to the KOSTAL Smart Energy Meter.

The arrow on the right can be used to drop down a detailed list of registers, which are contained in the respective groups.

The following registers can be activated or deactivated:

INFO

You will find information about the respective registers in the **KOSTAL Smart Energy Meter- Interface Description Modbus** documentation in the download area for the KOSTAL Smart Energy Meter.

Parameter	Explanation
Current values total	The current values for the entire system (registers 0–27)
Current values phases	The current values itemised by phase (registers 40-145)
Energy values total	The energy values for the entire system (registers 512-551)
Energy values phases	The energy values itemised by phase (registers 592-791)

4.13.4 Backup configuration

This item can be used to import or export the entire configuration of the Modbus configuration.

- Exporting the configuration allows the configuration currently saved to be downloaded as a file.
- Importing the configuration allows the configuration to be adopted from a previously exported file.

4.14 Menu - device settings

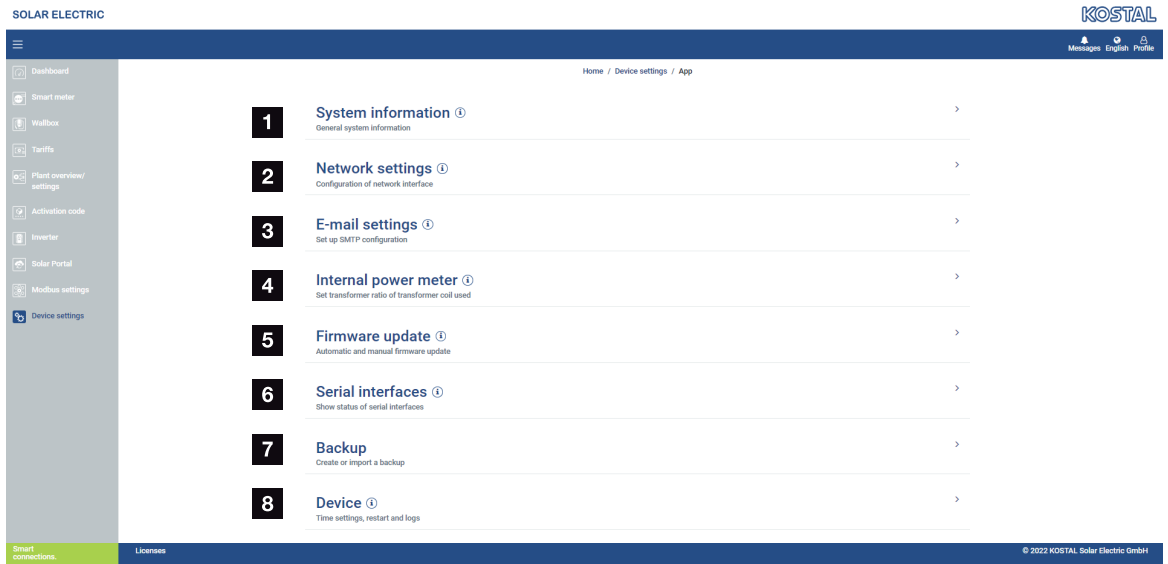

- 1 Shows general system information
- 2 Configuration of network interface
- 3 Configuration of e-mail to be informed of current events
- 4 If your device is connected to a transformer, the transformer ratio can be specified here **Internal power meter / transformer, Page 120**
- 5 **Firmware update** can be used to import a **manual update** and set the mode for the **automatic update**.
- 6 Shows the status of the serial interface
- 7 Create or import a backup
- 8 **Device** can be used to configure time settings, perform a restart or produce system logs.

4.14.1 System information

General system information as well as information about the current status of the system.

Parameter	Explanation
Product name	Indication of product name
Version	Version of the firmware installed
Serial number	Serial number of device
CPU usage	Current CPU load
RAM usage	Current RAM usage

Parameter	Explanation
Host name	Device name in network. Ex factory, this is set as KSEM-serial number designation. The name can be modified under the network settings.
IP address	IP address of the KOSTAL Smart Energy Meter, which was issued manually or by a DHCP server. NOTE! More information about the network settings can be accessed via the (i) next to the IP address. NOTE! A window opens containing the current settings for subnet mask, standard gateway and DNS server.
MAC address	MAC address of the KOSTAL Smart Energy Meter

4.14.2 Network settings

Here you can make changes to the IP settings.

INFO

Please note that improper settings may result in the user interface no longer being available.

Parameter	Explanation
Host name	The host name is the device's unique designation in the network. Any name can be chosen and may contain upper-case letters, lower-case letters, numbers and hyphens.
DHCP	When DHCP is activated, the device automatically obtains an IP address, e.g. from a router. No further settings are needed in this case. If a static IP address is to be set, DHCP must be deactivated and the Advanced settings opened. A static IP address, subnet mask, standard gateway and DNS server can be configured here. If UPnP is activated, the device is automatically detected by PCs in the same network and displayed in the network environment. This makes it easier for the user to find the device in the network if he or she doesn't know the IP address.

4.14.3 E-mail settings

If an event occurs, the KOSTAL Smart Energy Meter can inform you of it. To do this, you can set up configuration to your SMTP server (mail server) here, which will then inform you of various events via e-mail.

Set up SMTP configuration

i INFO

You will receive the data needed for the setup from your provider.

Parameter	Explanation
E-mail address	Enter your e-mail address here
SMTP server	Enter the name of the SMTP server here (e.g. securesmtp.t-online.de).
Port	Enter the port here (e.g. 465).
Use encrypted connection (TLS)	If encryption (SSL/TSL) is required, enable it here.
The server requires authentication	If a login is required, activate it here.
User name	Enter your login parameters for your SMTP server (mail server) here.
Password	

After the SMTP configuration, the settings should be tested. Use the test button to send a test message to the configured e-mail address. If you have received a test message, the settings are correct. Otherwise, correct them.

4.14.4 Internal power meter / transformer

The KOSTAL Smart Energy Meter can directly measure up to 63A per external wire. External transformers are used for higher currents. If your device is connected to a transformer, this can be set here.

i INFO

You will find a description of the electrical connection for transformers with an indirect measurement in the KOSTAL Smart Energy Meter's installation manual.

If transformers are being used, the following requirements are recommended. A list of recommended transformers can be found in the download area for the product.

- 100 A primary
- 5 A secondary
- Accuracy class 1

To do this, activate “Use current transformer” and set the transformer ratio. Common transformer ratios are provided in the drop-down list. If the ratio is not included in the list, click on “Other” and enter it manually. The primary current may be in a range of 1 to 5000 and the secondary current in a range between 1 A and 5 A.

4.14.5 Updating firmware

Here the device firmware of the KOSTAL Smart Energy Meter can be updated automatically or manually.

Parameter	Explanation
<i>Automatic updates</i>	<p><i>Automatic updates</i> The device regularly checks whether a firmware update is available and installs it automatically. The device restarts and is not available for a short period.</p> <p><i>Notify about available updates</i> The device regularly checks whether a firmware update is available. Updates are only installed once confirmed by the user.</p> <p><i>Manual updates</i> No automatic updates are carried out.</p>
<i>Manual update</i>	This menu item can be used to load a new device firmware for the KOSTAL Smart Energy Meter. To do this, select the update file and run the update. You can find the latest version on our website in the download area for the product.

4.14.6 Serial interface

Status information about the serial interfaces. This may either be assigned freely or by a particular application, the name of which is displayed here. The serial interface is configured in the relevant menus (e.g. Modbus settings or inverter)

4.14.7 Backup

Produce a password-protected backup to save the data and settings of the KOSTAL Smart Energy Meter.

Parameter	Explanation
Create	<p>This function can be to save the system settings and data captured. A password for protecting the data backup must be assigned via the Password field.</p> <p>While the backup file is being produced, the system does not take any measurements and there is a temporary interruption in communication.</p> <p>Press the Create button to start the backup process. Once the backup process is complete, a backup file (<i>Backup.bak</i>) can be downloaded from the browser.</p>
Import a backup	<p>A backup file can be selected using the Browse button.</p> <p>Clicking on Import opens the dialogue for importing the backup file.</p> <p>The password for the backup file can be entered here (if issued). Pressing the Import button starts the process.</p> <p>Please observe the information provided in the dialogue. All data and configurations are reset to those applicable at the time when the backup was created. Any data and configurations generated after this time are lost.</p> <p>Once the backup file has been successfully imported, the device restarts.</p>

4.14.8 Device

Configure general settings on the KOSTAL Smart Energy Meter.

Parameter	Explanation
Date and time	<p>Set date and time of device.</p> <p>NOTE! If you want to establish a connection to the Solar Portal, the time and time zone must be set/selected.</p> <p>Your time zone</p> <p>Set the time zone so that calendar-based adjustments, e.g. changes between summer and winter time, can be taken into account by the system.</p> <p>NTP</p> <p>If the KOSTAL Smart Energy Meter is permanently connected to the Internet via a network, we would recommend activating the “NTP” option. The time is then obtained from the Internet automatically via a server. In the advanced settings, you can also set an alternative NTP server.</p> <p>Set time</p> <p>The KOSTAL Smart Energy Meter runs internally with the UTC time only. This is converted into your local time zone for display purposes. If the KOSTAL Smart Energy Meter is not connected to the Internet or if automatic time synchronisation is not to be used, the time can also be set manually. The current system time and your current browser time are displayed on the interface for this purpose. Click on Set time to synchronise the two times. Your browser time is automatically converted into UTC and set as the KOSTAL Smart Energy Meter’s system time.</p>
Reset – device restart	<p>Click on “Restart” to restart the device. This may take several minutes. The online interface then has to be reloaded.</p>
Reset – reset device to state in which it was delivered	<p>Clicking on “Reset” resets the device to state in which it was delivered. The default password then applies again. To log in again, you will need the password from the energy meter’s type plate, which can be found on a separate instruction leaflet in the packaging.</p>
System logs	<p>This menu item can be used to download system log data as a text file for certain time periods.  Exporting log data, Page 127</p>

5. Faults / maintenance

5.1	Functions of the reset button	125
5.2	Error messages / displays	126
5.3	Exporting log data.....	127
5.4	Updating device firmware.....	128
5.5	Change password.....	129
5.6	Access tokens	130

5.1 Functions of the reset button

Restarting KOSTAL Smart Energy Meter

Press and hold the RESET button for more than 6 seconds with a sharp object.

The device will then start.

Resetting the online interface password

Press the reset button as follows:

- once for a lengthy period (between 3 and 5 seconds) and then
- once briefly (half a second).

The gap between the two should be no more than one second. If the command was detected correctly, the status LED flashes orange twice. The online interface password is reset to what it was upon delivery (see type plate on device).

INFO

To log in, you will need the password from the energy meter's type plate, which can also be found on a separate instruction leaflet in the packaging.

Resetting the network settings

Press the reset button as follows:

- once briefly (half a second) and then
- once for a lengthy period (between 3 and 5 seconds).

The gap between the two should be no more than one second. If the command was detected correctly, the status LED flashes orange twice. One result of resetting the network settings is that the DHCP is activated.

Resetting KOSTAL Smart Energy Meter to state in which it was delivered

Call up the Webserver. The device is reset by going to **Device settings > Device > Reset device to state in which it was delivered** and clicking on **Reset**.

INFO

After resetting, the default password applies again. To log in again, you will need the password from the energy meter's type plate, which can be found on a separate instruction leaflet in the packaging.

5.2 Error messages / displays

Status LED is not lighting up

The KOSTAL Smart Energy Meter is not connected to the power supply.

- Ensure that at least the external wire L1 and neutral wire N are connected to the KOSTAL Smart Energy Meter.

Status LED is lit up or flashing red

There is an error.

- Restart KOSTAL Smart Energy Meter. Use a pointed object to press the Reset button for at least 6 s.
- Please contact your service technician or installer.

Network LED is not lit up or the KOSTAL Smart Energy Meter is not found in the network

The network cable is not correctly connected to the grid connection.

- Ensure that the network cable is correctly connected to the grid connection.

The KOSTAL Smart Energy Meter is not in the same local network.

- Connect KOSTAL Smart Energy Meter with the same router / switch.

Serial bus LED is lit up red or flashing orange

In the user interface check whether there are any error messages about communication with the receiver.

- If necessary, check cabling to receiver.

KOSTAL Smart Energy Meter is providing unrealistic measuring values

The KOSTAL Smart Energy Meter has been installed the wrong way round.

- Recheck how L1 to L3 are connected.
- The transformers are not configured. Go to Device settings > Transformer ratio, activate transformer and set the correct transformer ratio.

User interface cannot be called up using the KOSTAL Smart Energy Meter's IP address or name

- Contact the network administrator.

5.3 Exporting log data

For service purposes, the log files can be downloaded from the KOSTAL Smart Energy Meter. The log data is then used by the service team for error rectification.

Do this by performing the following steps:

1. Call up online interface of KOSTAL Smart Energy Meter  **Calling up user interface, Page 74**
 2. Go to **Device settings > Device > System logs**.
 3. Select the time under **Logs since**.
 4. Press the **Download** button to start the download.
 5. Save the data to your PC.
- ✓ The download is complete. Now you can make the data available to the service team.

5.4 Updating device firmware

This menu item can be used to update the device firmware manually or automatically for the KOSTAL Smart Energy Meter.

Automatic update

If a firmware update is available, the update can be run in the KOSTAL Energy Meter using the following methods.

You can choose from two update methods. The selection must then be confirmed using the **Save** button.

- **Automatic updates**

The device regularly checks whether a firmware update is available and installs it automatically. The device restarts and is not available for a short period.

- **Notify about updates**

The device regularly checks whether a firmware update is available. Updates are only installed once confirmed by the user.

- **Manual updates**

No automatic updates are carried out.

Manual update

If you want to import an update manually, the following steps must be carried out:

1. Download the current firmware from our website by going to **Download > Accessories > KOSTAL Smart Energy Meter**.
 2. Use the **Browse** button to select the file on your PC.
 3. Press **Update** to start the update.
 4. Once a prompt has been accepted, the new firmware is uploaded and installed on the KOSTAL Smart Energy Meter.
- Finally the KOSTAL Smart Energy Meter is restarted. This process may take several minutes. The website then has to be reloaded.
- ✓ The software is installed.

5.5 Change password

The password can be changed by going to the following menu item.

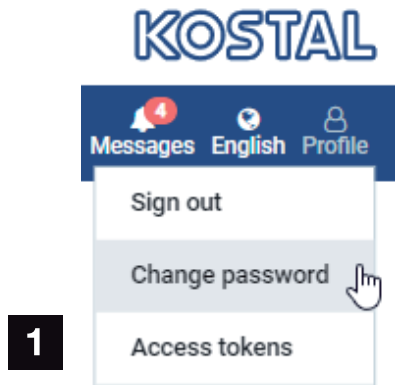

1 Change password

1. Call up **Change password** under **Sign out**.
 2. Start by entering the current password.
 3. Enter the new password. This must contain at least 8 letters and a mixture of upper- and lower-case letters.
 4. Enter the password again under **Confirm**.
 5. Confirm the input by selecting **Submit**.
- ✓ You have changed your password.

5.6 Access tokens

In order to grant an application access to the JSON interface (JavaScript Object Notation) or the web user interface of the KOSTAL Smart Energy Meter, the application must authorise itself with the KOSTAL Smart Energy Meter.

Authorisation uses an access token that was previously generated in the KOSTAL Smart Energy Meter.

Creating the access token

Access tokens can be created by going to **Profiles > Access tokens**.

The screenshot shows the 'Access tokens' management interface. The table contains the following data:

Name	Role	Date created	Expiration date	Status	Actions
dhe	admin,user	09/08/2022 11:52 AM	09/30/2022 12:00 AM	✓	REVOKE
dho	admin,user	09/08/2022 11:58 AM	09/09/2022 12:00 AM	□	REVOKE AUTHORISE

Clicking on **ADD** opens a window in which the name, role and expiry date of the access token can be specified.

Parameter	Explanation
Name	Name of the user, application or device that is to use the interface.
Role	<ul style="list-style-type: none"> ■ api: This can be used to query measurement data via the JSON interface. ■ admin: This can be used to log in to the web interface and configure settings. This access token has all the rights that a logged-in user has.
Expires on	Expiry date of the access token.

After creation, the access token is displayed once. It cannot be received or displayed again and should therefore be copied and stored securely upon receipt.

New access token ✕

Make sure you save the token as it will not be displayed again.

```
mölydffggkjldfg978ert09kjfdjopwetourgu9045hizng9rg43nifn430f-
nmva043ß09jrerß0ü32mölydffggkjldfg978ert09kjfdjopwetourgu9045hizng9rg43nifn430fn
mva043ß09jrerß0ü32mölydffggkjldfg978ert09kjfdjopwetourgu9045hizng9rg43nifn430fnm
va043ß09jrerß0ü32mölydffggkjldfg978ert09kjfdjopwetourgu9045hizng9rg4fnmva043ß09j
rerß0ü32mölydffggkjldfg978ert09kjfdjopwetourgu99jrerß0ü32mölydffggkjldfg978ert09kjf
dfjopwetourgu9045hizng9rg43nifn430fnmva043ß09jrerß0ü32
```

CLOSE

Authorisation of the access token

A newly issued access token must be authorised. By clicking on **AUTHORISE**, an access token is authenticated and authorised for use of the JSON interface and/or the web user interface.

Deleting the access token

An access token can be deleted from the system by clicking on **REVOKE**.

Using the API access token

Once an API access token has been authenticated and authorised by the user, it can be used by the application for JSON interface requests.

To do this, the access token is transmitted as part of the HTTP header:

```
GET /api/json/<resource>HTTP/1.1
Host: <energy manager>
Content type: application/json
Authorisation: Bearer eyJhbGciOiJSUzI1NiIsInR5cCI6IkpXVCJ9[...]
```

Using the admin access token

Once an admin access token has been authenticated and authorised by the user, it can be used by the application to display the web user interface.

To do this, the access token is transmitted as part of the HTTP header and/or must be stored in the browser's local memory in order to be read from there.

TTL access token

The life of an access token can be limited during the authentication request. For this purpose, an expiry date is defined in addition to the name of the application. Furthermore, a logged-in user can withdraw an issued access token via the web interface. All subsequent requests made using a withdrawn access token will be rejected.

