

**GOODWE**



# **User Manual**

## **Rechargeable Li-ion Battery System**

**Lynx C Series**

V 1.1 2023-07-30

**Copyright ©GoodWe Technologies Co., Ltd., 2023. All rights reserved**

No part of this manual can be reproduced or transmitted to the public platform in any form or by any means without the prior written authorization of GoodWe Technologies Co., Ltd.

**Trademarks**

**GOODWE** and other GOODWE trademarks are trademarks of GoodWe Technologies Co.,Ltd. All other trademarks or registered trademarks mentioned in this manual are owned by GoodWe Technologies Co.,Ltd.

**NOTICE**

The information in this user manual is subject to change due to product updates or other reasons. This guide cannot replace the product labels or the safety precautions in the user manual unless otherwise specified. All descriptions in the manual are for guidance only.

# Content

<b>01 About This Manual.....</b>	<b>IV</b>
1.1 Applicable Model.....	IV
1.2 Target Audience.....	IV
1.3 Symbol Definition.....	IV
1.4 Updates.....	IV
<b>02 Safety Precaution.....</b>	<b>01</b>
2.1 General Safety .....	01
2.2 Installation Precaution.....	01
2.3 Maintenance Precaution .....	03
2.4 Battery Safety .....	03
2.5 Emergency Measures .....	03
2.6 EU Declaration of Conformity.....	03
<b>03 Product Introduction.....</b>	<b>04</b>
3.1 Product Overview.....	04
3.2 Battery Cabinet .....	05
3.3 PCU .....	06
3.4 Indicator .....	07
3.5 Battery Module .....	07
3.6 Nameplate .....	08
<b>04 Storage and Package.....</b>	<b>09</b>
4.1 Storage Environment .....	09
4.2 Packing List.....	09
<b>05 System Installation.....</b>	<b>11</b>
5.1 Installation Environment.....	11
5.2 Space Requirements .....	11
5.3 Angle Requirements.....	12
5.4 Moving the BS.....	12
5.5 Installing the BS.....	12
<b>06 Electrical Connection .....</b>	<b>15</b>
6.1 Connecting PE Cable.....	15
6.2 Connecting Battery Communication Cable .....	16
6.3 Connecting Inverter Communication Cable.....	17
6.4 Connecting Power Connecting Bar .....	17
6.5 Connecting Inverter Power Cable .....	18
6.6 (Optional) Connecting Single Phase AC Power Cable .....	19

- 07 System Operation..... 20**
  - 7.1 Check before Power ON ..... 20
  - 7.2 Power ON ..... 20
  - 7.3 Indicator..... 21
  - 7.4 Parameter Setting..... 21
  - 7.5 Power OFF ..... 22
- 08 Maintenance ..... 23**
- 09 Parameters ..... 24**



# 01 About This Manual

This manual describes the product information, installation, electrical connection, commissioning, troubleshooting and maintenance of Lynx C Series Rechargeable Li-ion Battery System for Commercial and Industries (hereinafter referred to as the Lynx C BS in short). Read through this manual before installing and operating the product. All the installers and users have to be familiar with the product features, functions, and safety precautions. This manual is subject to update without notice. For more product details and latest documents, visit <https://en.goodwe.com>.

## 1.1 Applicable Model

This manual applies to the listed Lynx C BS below:



Model	Usable Energy (kWh)
LX C101-10	101.38
LX C120-10	119.81
LX C138-10	138.24
LX C156-10	156.67

## 1.2 Target Audience

This manual applies to trained and knowledgeable technical professionals. The technical personnel has to be familiar with the product, local standards, and electric systems.

## 1.3 Symbol Definition

Different levels of warning messages in this manual are defined as follows:

 <b>DANGER</b>
Indicates a high-level hazard that, if not avoided, will result in death or serious injury.

Indicates a medium-level hazard that, if not avoided, could result in death or serious injury.
 <b>CAUTION</b>
Indicates a low-level hazard that, if not avoided, could result in minor or moderate injury.
<b>NOTICE</b>
Highlight and supplement the texts. Or some skills and methods to solve product-related problems to save time.

## 1.4 Updates

The latest document contains all the updates made in earlier issues.

### V1.1 2023-07-30

Updated **3.5 Battery Module** and **7.4 Parameter Setting**.

### V1.0 2022-10-15

First Issue

## 02 Safety Precaution

### NOTICE

The Lynx C BS are designed and tested strictly in compliance with related safety rules. Read and follow all the safety instructions and cautions before any operations. Improper operation might cause personal injury or property damage as the products are electrical equipment.

### 2.1 General Safety

#### NOTICE

- The information in this user manual is subject to change due to product updates or other reasons. This guide cannot replace the product labels or the safety precautions in the user manual unless otherwise specified. All descriptions here are for guidance only.
- Read through this document before installation to learn about the product and the precautions.
- All operations should be performed by trained and knowledgeable technicians who are familiar with local standards and safety regulations.
- Use insulating tools and wear personal protective equipment (PPE) when operating the Lynx C BS products to ensure personal safety.
- Strictly follow the installation, operation, and configuration instructions in this manual. The manufacturer shall not be liable for equipment damage or personal injury if you do not follow the instructions. For more warranty details, visit: <https://en.goodwe.com/warranty>.

### 2.2 Installation Precaution

















#### WARNING

- Please keep Power Off before any operations to avoid danger. Strictly follow all safety precautions outlined in this manual and safety labels on the equipment.
- The Lynx C BS is a high voltage system. Do not touch or operate it. Keep away from it. Only professionals are allowed!
- Please use appropriate tools and take protective measures when installing and maintaining heavy equipment. Improper operations will cause personal injuries.
- Do not use the battery module or Power Control Unit (hereinafter referred to as PCU in short) if it is defective, broken, or damaged.
- Do not disassemble, modify, or replace any part of the battery module or PCU without official authorization from the manufacturer.
- Pay attention to the negative and positive during installation to avoid reverse polarity connection. Otherwise the short circuit may cause personal injuries and damage to the equipment.

**DANGER**

- All labels and warning marks should be visible after the installation. Do not scrawl, damage, or cover any label on the device.
- Warning labels on the BS are as follows.

**Symbol Description**

Symbol	Description	Symbol	Description
	Potential risks exist. Wear proper personnel protectives before any operations.		Install the equipment away from fire sources.
	HIGH VOLTAGE HAZARD. High voltage exists during the equipment's running. Ensure the equipment is power off before any operations.		Keep the equipment away from children.
	Operate the equipment properly to avoid explosion.		No extinguishing with water.
	The equipment contains corrosive electrolytes. In case of a leak in the equipment, avoid contact the leaked liquid or gas.		Do not dispose of the equipment with household garbage at its end of life. Dispose it according to local laws and regulations. Or send it to the manufacturer.
	Batteries contain flammable materials. Beware of fire.		Put the battery in the right place and recycle it in compliance with local environmental regulations.
	Read through the user manual before any operations.		Pay attention to safety protection during installation, operation and maintenance.
	No stepping.		Grounding. To indicate PE cable connection position.
	CE Marking.		TUV Marking.
	RCM Marking.	-	-

## 2.3 Maintenance Precaution

### WARNING

- Do not pull or plug the terminals and connecting cables during the running of the BS. Otherwise it may cause dangers to the safety.
- Contact After-sales Service if the battery module shall be replaced or added.
- Power off the BS the moment there is abnormality happening during the running. Contact the related personnel as soon as possible.
- Do not hit, pull, drag, or step on the equipment, or stab into the cover of the equipment with sharp objects, or put unrelated items into any part of the battery cabinet.

## 2.4 Battery Safety

### WARNING

- Do not charge the battery at lower temperature. Otherwise it may decrease the capacity of the BS.
- Do not dis-/charge the battery exceeding the nominal dis-/charge current.
- It is strictly forbidden to reverse the polarity connection. Otherwise the strong current or high temperature generated from the battery may cause personal injury or fire risk.

## 2.5 Emergency Measures

### WARNING

Damaged battery modules may leak electrolyte. Do not contact the electrolyte or volatile gas once there is leakage. Please ask After-sales Service for help immediately.

Anyone contact the leakage accidentally has to do as the following:

- Inhalation:  
Evacuate from the contaminated area, and seek immediate medical assistance.
- Eye contact:  
Rinse your eyes for at least 15 minutes with clean water and seek immediate medical assistance.
- Skin contact:  
Thoroughly wash the touch area with soap and clean water, and seek immediate medical assistance.
- Ingestion:  
Induce vomiting, and seek immediate medical assistance.

## 2.6 EU Declaration of Conformity

The Lynx C BS sold in the European market meets the following directives and requirements:

- Electromagnetic compatibility Directive 2014/30/EU (EMC)
- Electrical Apparatus Low Voltage Directive 2014/35/EU (LVD)
- Restrictions of Hazardous Substances Directive 2011/65/EU and (EU) 2015/863 (RoHS)
- Waste Electrical and Electronic Equipment 2012/19/EU
- Registration, Evaluation, Authorization and Restriction of Chemicals (EC) No 1907/2006 (REACH)

You can download the EU Declaration of Conformity on the official website: <https://en.goodwe.com>.

## 03 Product Introduction

### 3.1 Product Overview

- This manual is mainly about product introduction, application scenarios, installation, commissioning, maintaining and technical parameters of the Lynx C BS.
- The Lynx C BS is mainly composed of Lynx C series battery modules, PCU and battery cabinet.
- Below are the inverters applicable in the Lynx C BS:



GoodWe Inverter

Below are the configurations about different BS:

BS Model	PCU Quantity	Battery Cabinet Quantity	Battery Module Quantity
LX C101-10	1	1	11
LX C120-10	1	1	13
LX C138-10	1	1	15
LX C156-10	1	1	17

### 3.2 Battery Cabinet

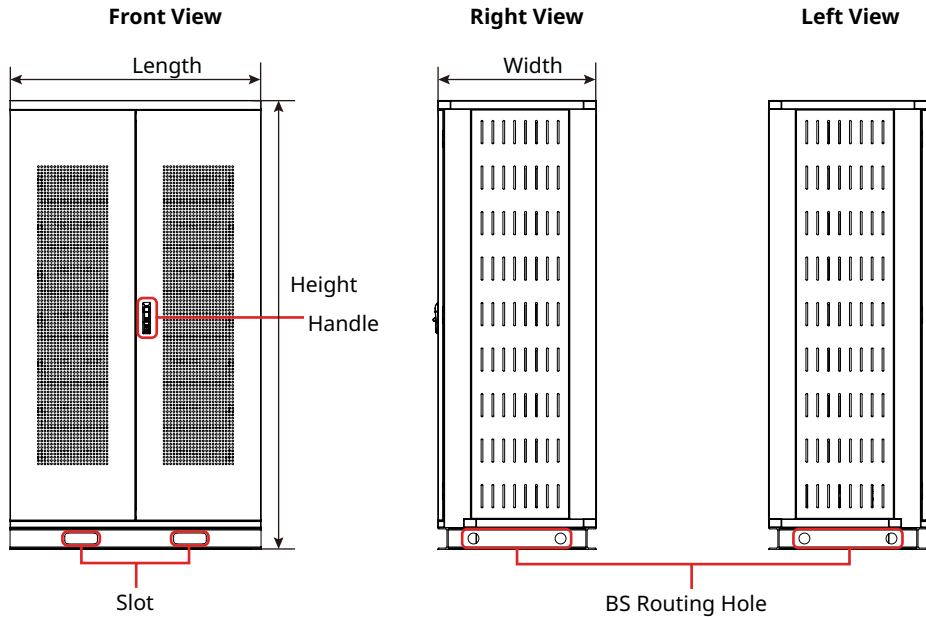

Model	Length (mm)	Width (mm)	Height (mm)
LX C101-10	1155	730	1650
LX C120-10			
LX C138-10	1155	730	2065
LX C156-10			

### 3.3 PCU

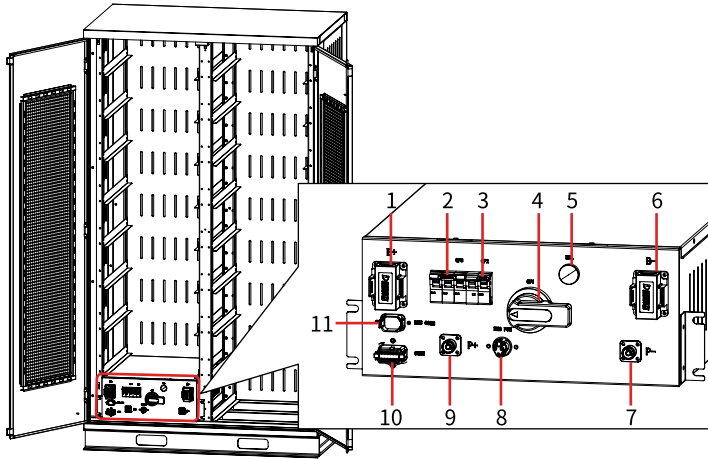

No.	Silk Print	Parts	Description
1	B+	Battery positive terminal	To connect with the positive polarity of the battery module.
2	QF3	DC circuit breaker	Used when the BS is self-powered.
3	QF2	AC circuit breaker	Used when the BS requires external power supply.
4	QF1	Main circuit breaker	The main circuit breaker for the BS.
5	HRL	Indicator	To display the working status of BS.
6	B-	Battery negative terminal	To connect with the negative polarity of the battery module.
7	P-	Power input/output port (Negative)	To connect the inverter negative power port.
8	BMS POW	AC power supply port	To connect the inverter AC output port.
9	P+	Power input/output port (Positive)	To connect the inverter positive power port.
10	COM	External COM port	To connect the inverter for communication.
11	BMU COM	Internal COM port	To connect the battery module for communication.

### 3.4 Indicator

No.	Red	Green	Description
1		ON	The BS is in operation.
2		SINGLE FLASH	The BS is in idle status.
3		DOUBLE FLASHES	The BS is on standby.
4	SINGLE FLASH		Slight alarm
5	DOUBLE FLASHES		Medium alarm
6	ON		A fault has occurred.

### 3.5 Battery Module

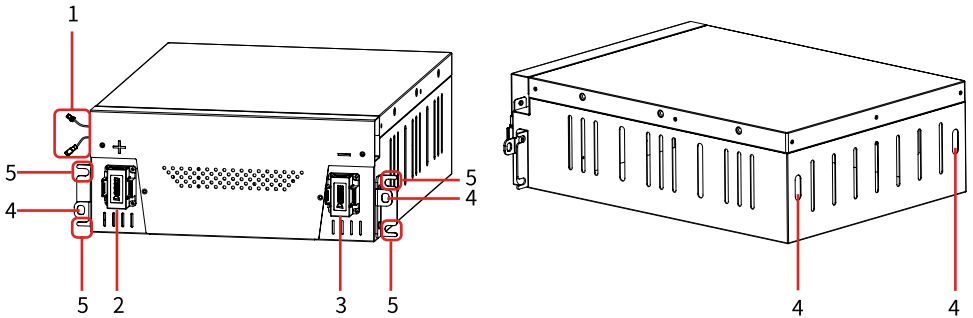

No.	Parts	Description
1	Connector for battery communication	To connect PCU or other battery modules for communication.
2	Battery positive polarity	-
3	Battery negative polarity	-
4	Battery hoisting hole	To hoist the battery modules into the cabinet.
5	Battery fixing hole	To fix the battery modules within the cabinet.

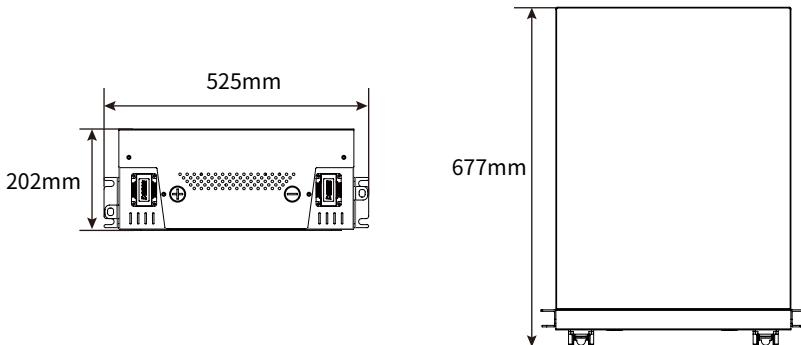





## 04 Storage and Package

### 4.1 Storage Environment

If the equipment is not to be installed or used immediately, please ensure that the storage environment meets the following requirements:





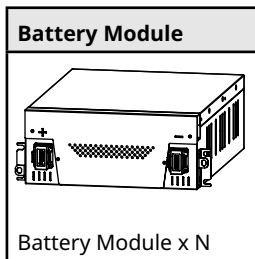

- Pack the equipment into a packing box and put some desiccant in the box before sealing.
- Put the equipment back in the packing box if it is not to be installed in 3 days after unpacking.
- If the battery modules are going to be kept for more than 30 days, adjust SOC to 40%-60% and dis-/charge them once every 3 months.
- Recommended storage temperature:  
0°C~35°C (less than one year), -20°C~0°C or 35°C~40°C (less than one month).
- Recommended storage humidity: 0%~95%RH (no condensation). Do not install the battery if there is moisture or condensation.
- Place the equipment in a cool place, far away from the direct sunlight.
- Keep the equipment away from flammable, explosive, and corrosive matters.
- Keep the equipment away from the rain.
- Protect the BS from damage during transportation and storage.
- It is strictly forbidden to put the batteries into fire. Otherwise it might be exploded.
- It might cause a fire to the BS when the ambient temperature exceeds 150°C.

### 4.2 Packing List

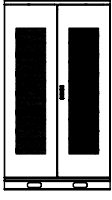
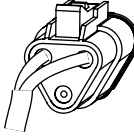
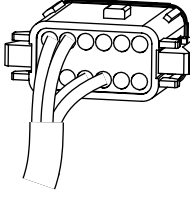
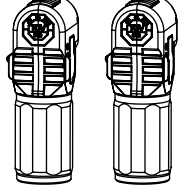
- The packing of the BS is mainly composed of the packages of the battery modules and the battery cabinet.
- Check whether the packing is damaged and confirm the BS model before unpacking. Do not unpack the product if you find any damage or the model is not what you requested. Contact After-sales Service as soon as possible.
- Check whether the deliverables are intact and complete first after unpacking. Contact the After-sales Service as soon as possible for anything wrong.

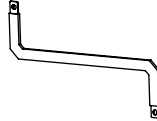
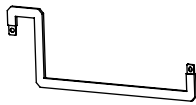

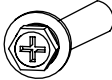
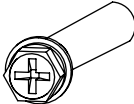
No.	Model	Battery Module Quantity (Pieces)
1	LX C101-10	11
2	LX C120-10	13
3	LX C138-10	15
4	LX C156-10	17

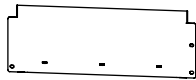
Battery Cabinet and Accessories			
			
Battery cabinet x 1*1	AC connector x 1	COM connector x 1	Power output connector x 1
			
Battery power connecting bar A x 1	Battery power connecting bar B x 1	Battery power connecting bar C x 1	Battery power connecting bar D x 1
			
COM cable between PCU and battery x 1	COM cable between batteries x N	M6 screw x N	M8 screw x N
		NA	NA
Mounting hook x 4	Sealing plate x N		

- All the other accessories except the battery cabinet are put in the battery cabinet.
- The quantity of AC connectors depends on the specific BS configuration.

Accessories	LX C101-10	LX C120-10	LX C138-10	LX C156-10
Battery power connecting bar (pieces)	9	11	13	15
Battery COM cable (pieces)	10	12	14	16
M6 screw (pieces)	56	56	72	72
M8 screw (pieces)	24	28	32	36
Sealing plate (pieces)	2	0	2	0

## 05 System Installation

### 5.1 Installation Environment

- Install the BS on a flat ground with sufficient bearing capacity. Increase the bearing capacity and flatness of the ground by laying the foundation, adding bearing plates, and so on.
- The BS shall be installed indoor.
- The optimal working temperature for the BS is 20~40°C.
- The working temperature for the BS shall not exceed 50°C.
- Install the equipment away from heat/cold source.
- Do not install the equipment in a place where the temperature changes extremely.
- Install the equipment away from strong interferences.
- Keep children away from the equipment.
- Do not install the equipment in places prone to accumulate water.
- Do not put flammable or explosive matters near the equipment.
- In the event of a fire, please make sure that the carbon dioxide extinguisher or Novac1230 or FM-200 is nearby. The fire cannot be put out by water or ABC dry powder extinguisher. Firefighters are required to wear full protective clothing and self-contained breathing apparatus.

### 5.2 Space Requirements

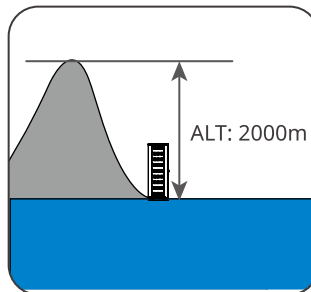
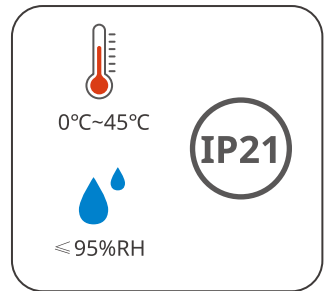
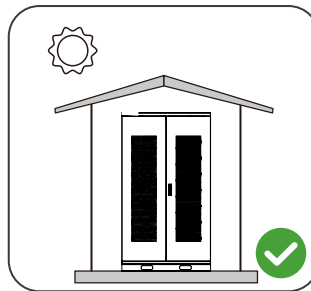
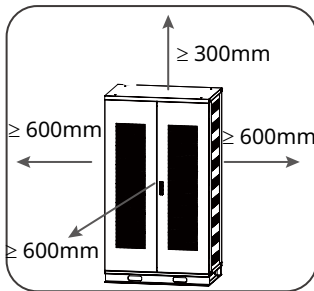

## 5.3 Angle Requirements

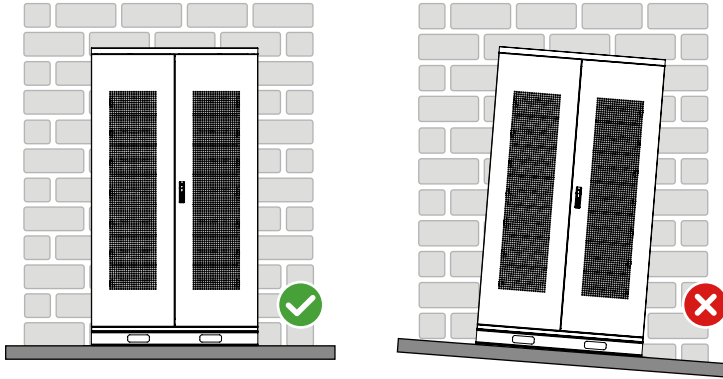

## 5.4 Moving the BS

### CAUTION

Move the BS to the site before installation. Follow the instructions below to avoid personal injury or equipment damage.

1. Consider the weight of the equipment before moving it. Assign enough personnel to move the equipment to avoid personal injury.
2. Keep the equipment in balance to avoid its falling down during moving.

## 5.5 Installing the BS

### NOTICE

- Ensure that the ground is flat.
- Ensure that the battery cabinet is vertically standing on the ground without risk of inclination.

**Step 1** Use the fork lift to move the battery cabinet to the installing place.

**Step 2** Open the battery cabinet and take out the accessory package.

**Step 3** Use the hook to move the battery module to the fork lift or elevating devices.

**Step 4** Use the fork lift or the elevating devices to install each battery module into the battery cabinet from bottom to top. For LX C101-10 and LX C138-10, do not install any battery module on the top layer.

**Step 5** Use M6 screws to fix the battery module and the sealing plate (the sealing plate is only used on the top layer for LX C101-10 and LX C138-10).

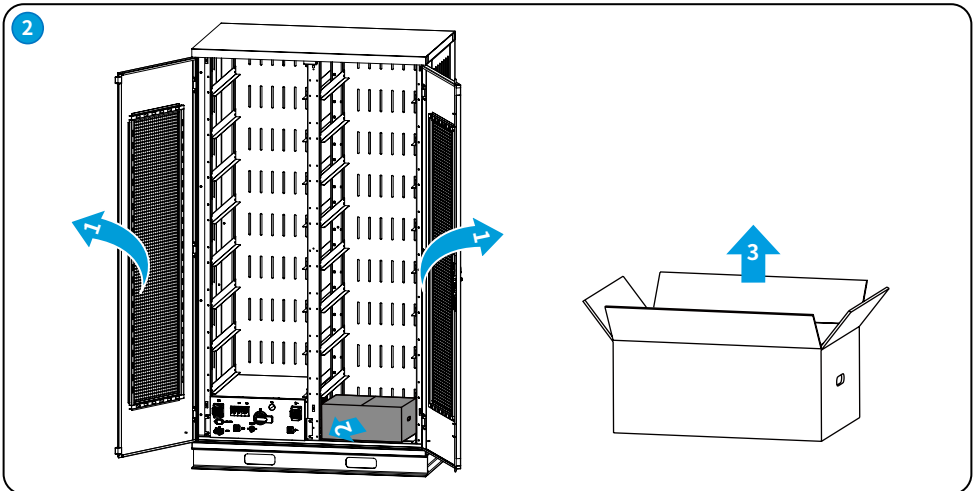
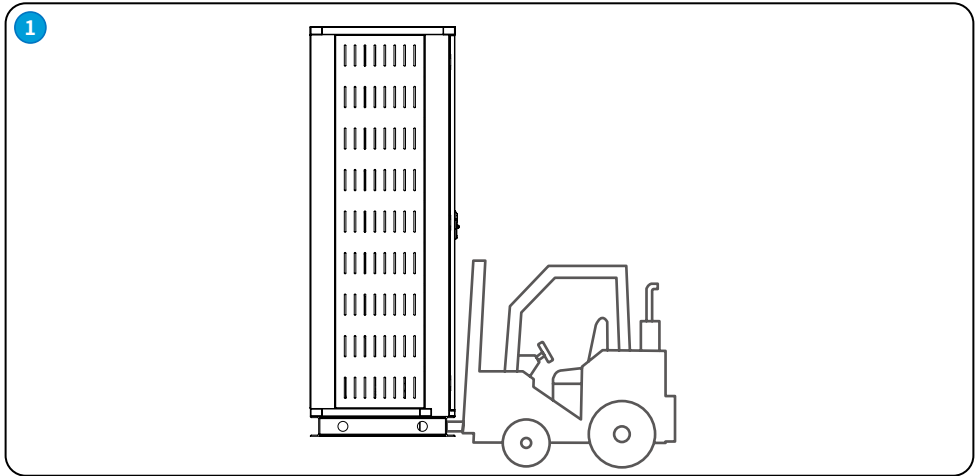

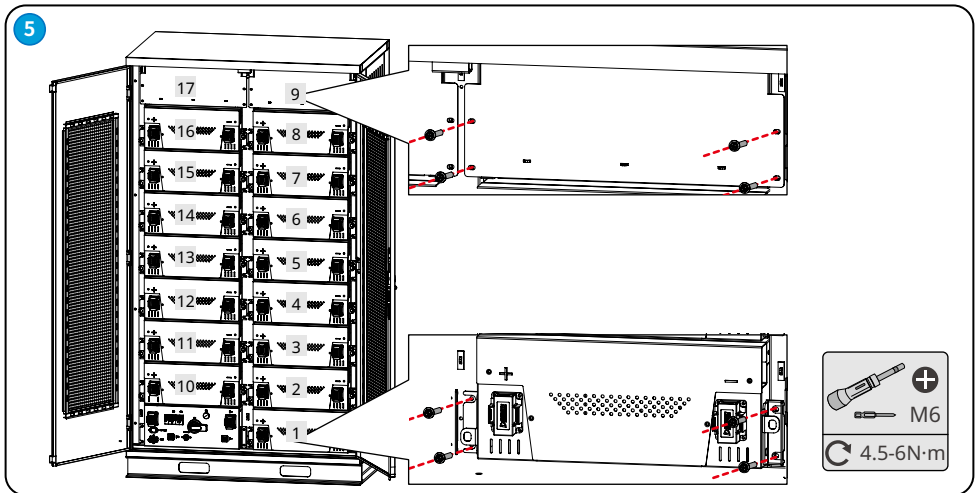
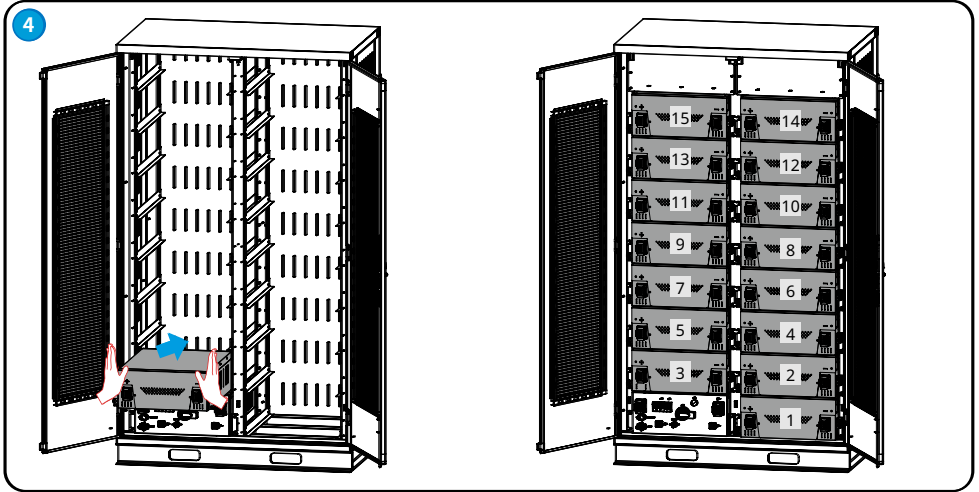
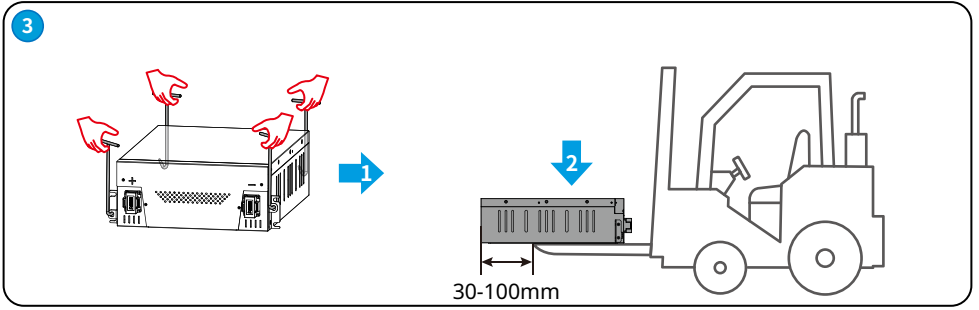

## 06 Electrical Connection

### WARNING

- Ensure all switches of PCU and its upstream switches are disconnected before any electrical connections.
- Place the cables at least 30mm away from the heating components or heat sources, otherwise the insulation layer of the cables may be aging or broken due to high temperature.
- Tie the cables of the same type together, and place cables of different types at least 30mm apart. Do not place the cables entangled or crossed.

### 6.1 Connecting PE Cable

#### NOTICE

- Connect the PE cable first before electrical connection. Disconnect the PE cable at last during dismantling the equipment.
- The PE cable should be prepared by customers. The cross-sectional area of the PE cable conductor: 8mm<sup>2</sup>.

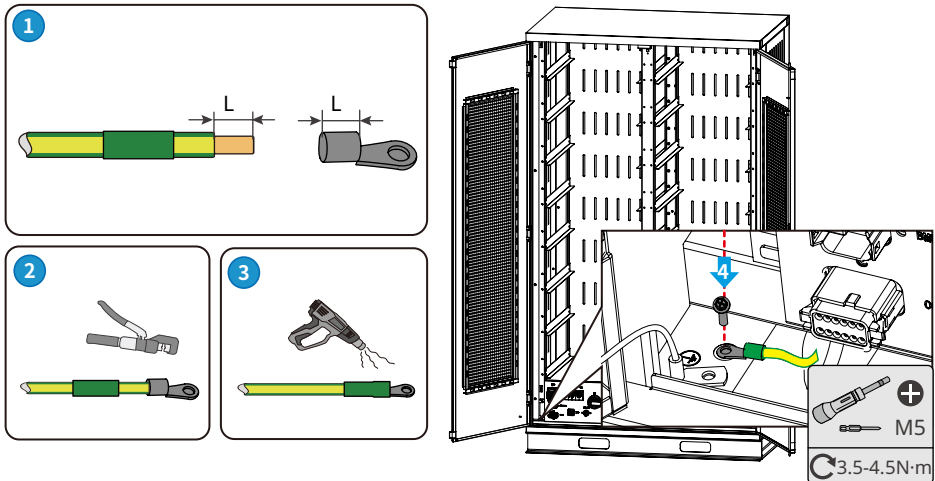



## 6.2 Connecting Battery Communication Cable

### NOTICE

- There are two communication ports on PCU: one is to connect the internal battery; the other is to connect the external inverter.
- The communication cables and terminals are delivered with the product.
- Use the correct communication cables.

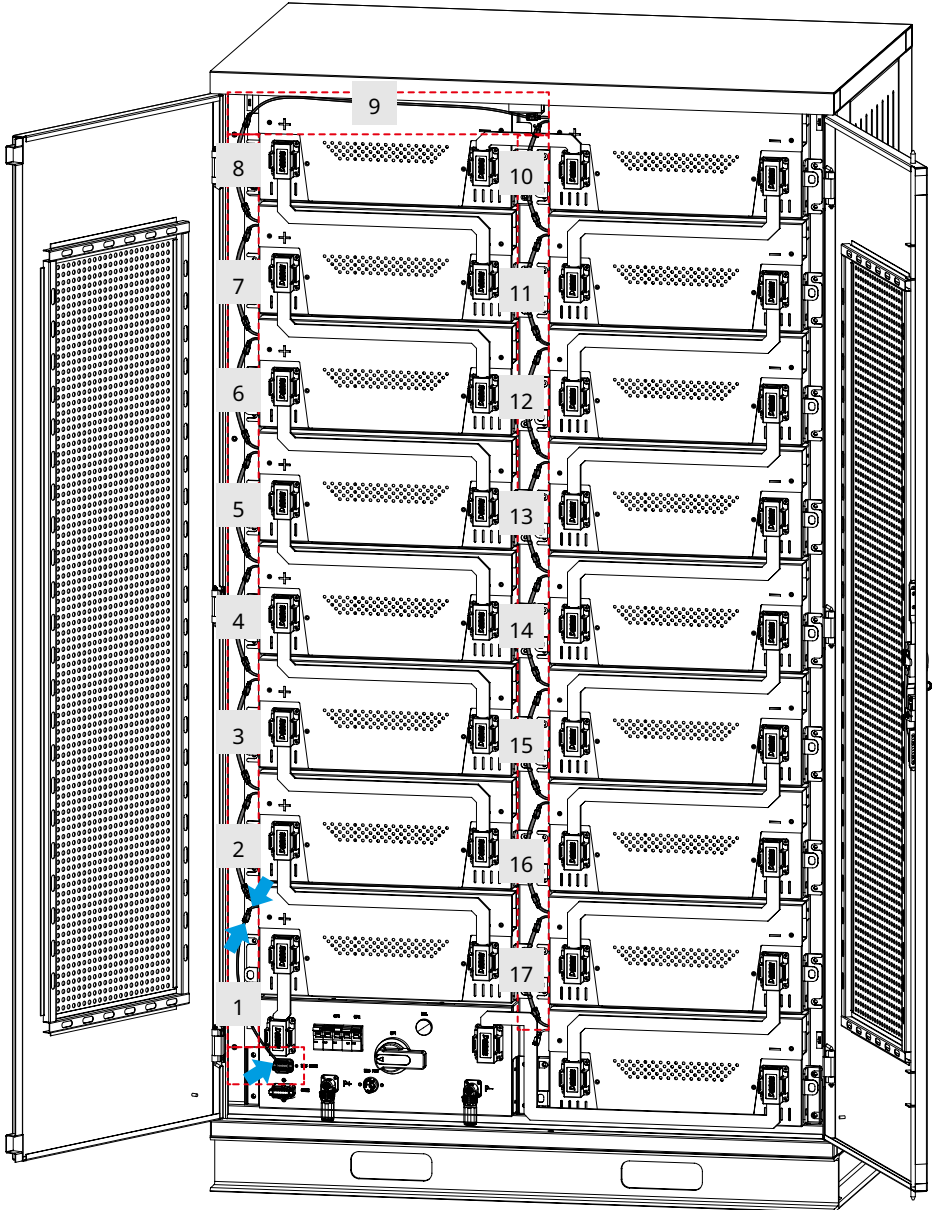

### 6.3 Connecting Inverter Communication Cable

#### NOTICE

- The communication cables are required when the BS is used together with the inverters.
- The communication terminals and cables of the BS are delivered with the product.

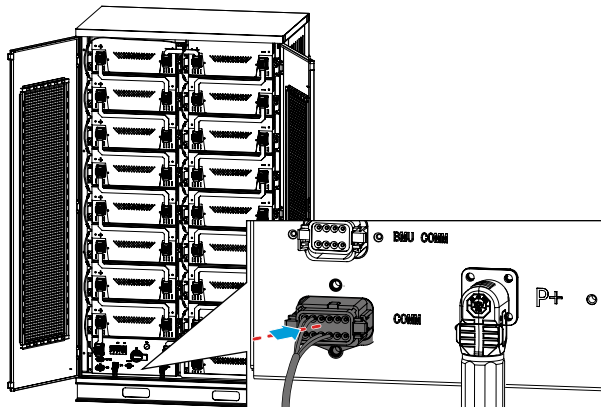

No.	Definition
3	CANH
4	CANL
7	RS485A
8	RS485B
Others	NA

### 6.4 Connecting Power Connecting Bar

#### NOTICE

- Disconnect all switches of PCU before connecting the battery power connecting bar.
- Use the battery power connecting bar in the accessory list.
- There are varies of battery power connecting bars. Choose the proper one according to the actual connecting locations. The connecting way and torque are the same for different shapes of battery power connecting bars. Refer to the following steps for the connection.
- Use the correct battery power connecting bar.

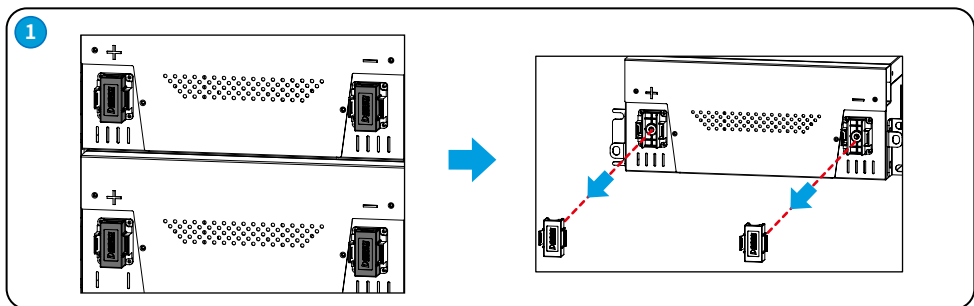

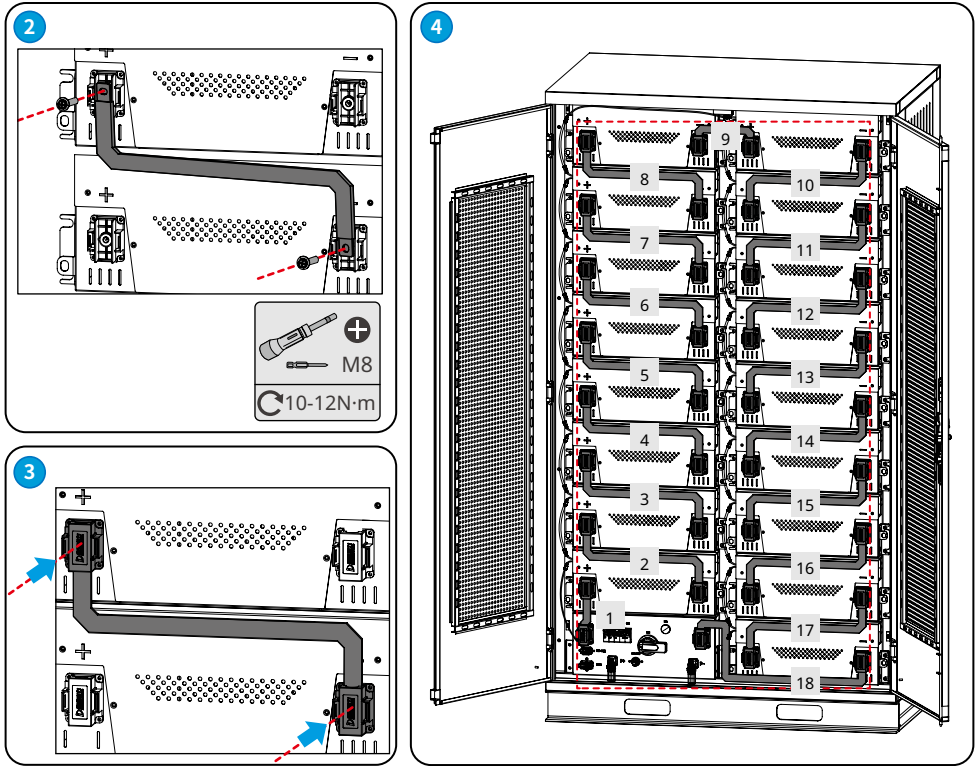

## 6.5 Connecting Inverter Power Cable

### NOTICE

- The cross-sectional area of the power cable is  $35\text{mm}^2$  (AWG 2); its outer diameter is 11-13mm; the stripping length is  $20\pm 1\text{mm}$  and the crimping height is  $9\pm 0.2\text{mm}$ . Ensure the drawing force is more than 2500N after crimping.
- The power cable shall be normal 1000V PV cables.
- The orange power terminals are positive and the black power terminals are negative.

Step 1 Strip the conductor from the cable.

Step 2 Insert the cable into the power connector. Then use tools to crimp it.

Step 3 Tighten the rear housing of the power connector.

Step 4: Connect the power cable.

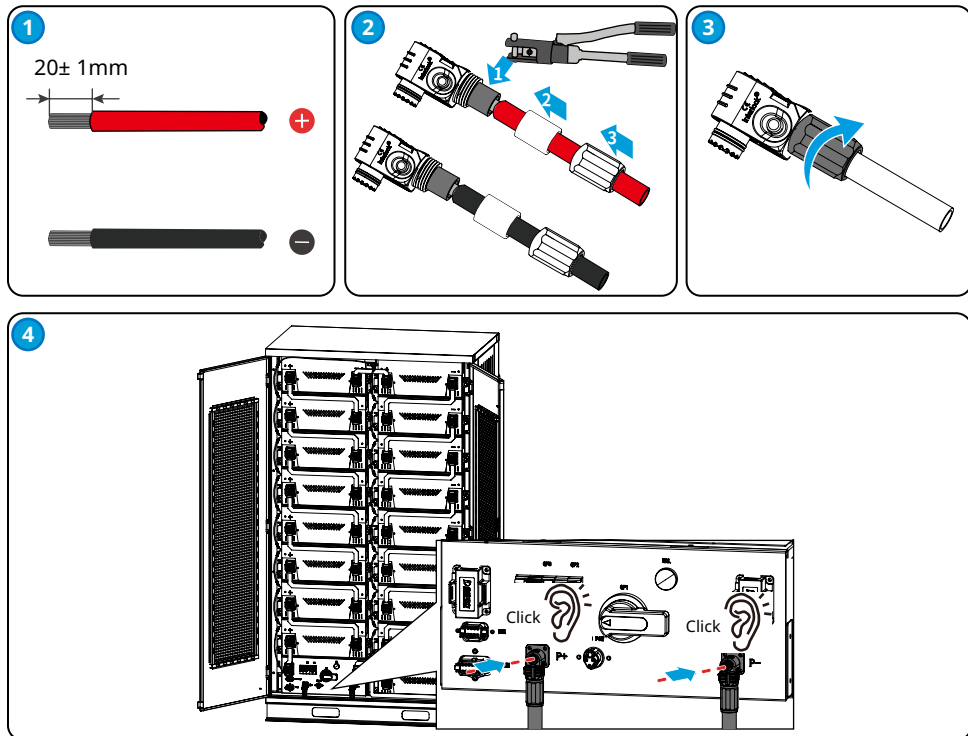

## 6.6 (Optional) Connecting Single Phase AC Power Cable

### NOTICE

- The BS is able for DC self-powered, as well as Single Phase AC supplying externally. The single phase AC cable is used for external power supply. Choose whether to use it based on the actual demanding.
- For single-phase AC power, use UPS (Uninterruptible Power Supply).
- The input voltage scope for the single phase AC power is 100-240V; power:  $\geq 60W$  and frequency: 50-60Hz.
- The single phase AC terminals and cables are delivered with the product.

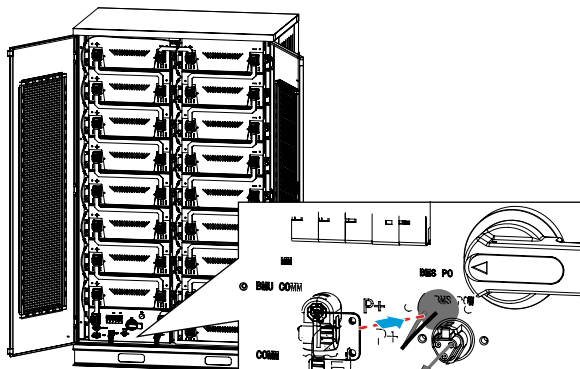

## 07 System Operation

### 7.1 Check before Power ON

Check the following items before power on to avoid the battery system being damaged.

No.	Check Item
1	The equipment is firmly installed in a clean place where is well-ventilated and easy to operate.
2	Ensure that PE, the battery high voltage copper bus, the inverter power cable, the communication cable and single phase AC cable are connected correctly and securely.
3	Cable ties are intact, routed properly and evenly.

### 7.2 Power ON

#### NOTICE

Turn on QF3 when PCU is self-powered; turn on QF2 when it is using external single phase AC powering.

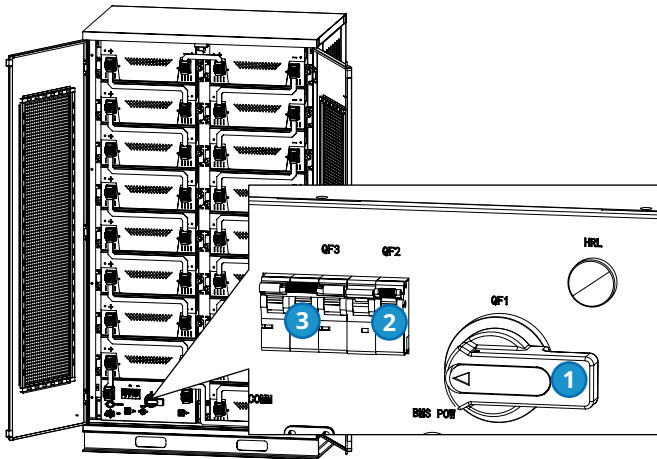

#### Power On

Self-powered:



External single phase AC powering:



### 7.3 Indicator

No.	Red	Green	Description
1	-	ON	The BS is in operation.
2		SINGLE FLASH	The BS is in idle status.
3		DOUBLE FLASHES	The BS is on standby.
4	SINGLE FLASH	-	Slight alarm
5	DOUBLE FLASHES		Medium alarm
6	ON		A fault has occurred.

### 7.4 Parameter Setting

Select the battery model via SolarGo App after successfully connecting the BS and the inverter. APP installation and connection

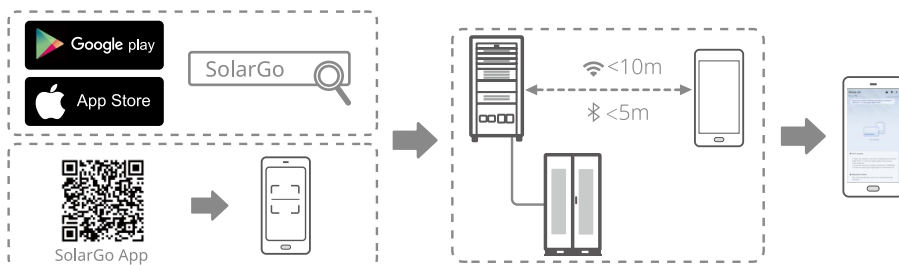

Set battery model via the SolarGo App.

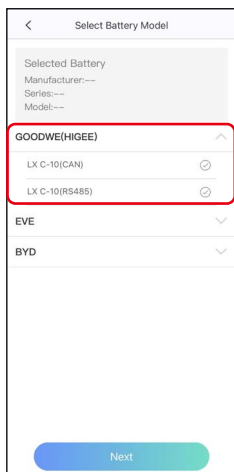

Click "GOODWE(HIGEE)" and then select the proper battery model matching with the communication method on "Select Battery Model" page of the SolarGo App.

#### NOTICE

"Battery Selection Abnormal" will prompt when choosing a wrong battery model. Please select the right battery model accordingly.

## 7.5 Power Off

Follow the steps to power off the BS to avoid the system being damaged.

### NOTICE

Ensure there is no load on the DC side of the inverter and the circuit breaker between the BS and the inverter is disconnected before power off the BS.

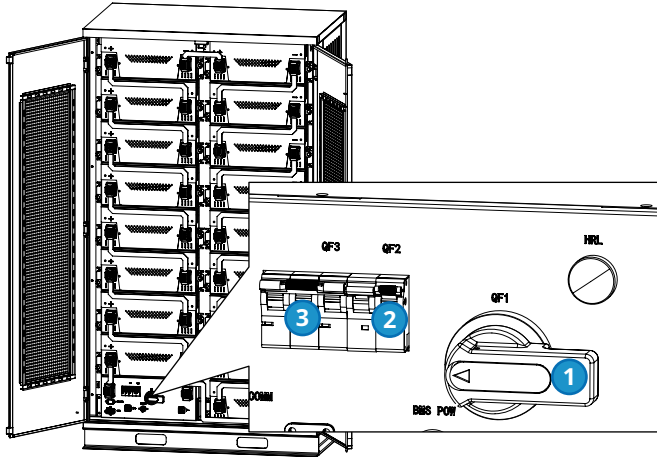

### Power Off

Self-powered:



External single phase  
AC power supplying:



## 08 Maintenance

### DANGER

Power off the Lynx C BS before operations and maintenance. Otherwise, the equipment may be damaged or electric shocks may occur.

### WARNING

- Contact After-sales Service for help if you find any problems that may influence the BS or the hybrid inverter. It is strictly forbidden to disassemble without permission.
- Contact After-sales Service for help if the copper conductor is exposed. Do not touch or disassemble privately because the high voltage danger exists.
- In case of other emergencies, contact After-sales Service as soon as possible. Follow the instructions to operate or wait for After-sales Service to help.

Item	Maintaining Period
Check whether the door is normal.	Once every 6 months
Check whether the wiring of PCU and of the batteries are securely in the battery cabinet.	Once every 6 months
Check whether there is an exposed cable. Replace the exposed cable or contact After-sales Service for help.	Once every 6 months
Check whether there is debris accumulated around the battery cabinet to avoid affecting the battery radiating.	Once every 6 months
Check whether there is liquid, pest or debris within the battery cabinet to avoid an intrusion.	Once every 6 months



## 09 Parameters

Technical Data		LX C 101-10	LX C120-10
Usable Energy (kWh)* 1		101.38	119.81
Battery Module		LX C9.2-10: 38.4V 9.21kWh	
Number of Modules		11	13
Cell Type		LFP (LiFePO4)	
Cell Configuration		132S2P	156S2P
Nominal Voltage (V)		422.4	499.2
Operating Voltage Range (V)		369.6~468.6	436.8~553.8
Nominal Dis-/Charge Current (A) <sup>*2</sup>		100	
Nominal Power (kW) <sup>*2</sup>		42.24	49.92
Short-Circuit Current		4.0kA 0.66ms@468.6V.dc	4.1kA 0.62ms@553.8V.dc
Operating Temperature (°C)		Charge: 0 ~ +45 / Discharge: -20 ~ +50	
Relative Humidity(%)		0~95%	
Max. Operating Altitude (m)		2000	
Communication		CAN+RS485	
Weight (Kg)		1120	1280
Dimensions (W×H×D) (mm)		1155×1650×730	
Ingress Protection Rating		IP21	
Storage Temperature (°C)		0~+35 (< One Year); -20~0 or +35~+45 (< Three Months)	
Mounting Method		Grounded	
Round-trip Efficiency <sup>*1</sup>		96.0%	
Cycle Life <sup>*3</sup>		4000	
Standard and Certification	Safety	IEC62619, IEC62040, IEC63056	
	EMC	IEC/EN61000-6-1/2/3/4	
	Transportation	UN38.3	
<p>*1: Test conditions, 100% DOD, 0.2C charge &amp; discharge at +25±2 °C for battery system at beginning life. System Usable Energy may vary with different Inverter.</p> <p>*2: Nominal Charge/Discharge and power derating will occur related to Temperature and SOC.</p> <p>*3: Based on 2.5~3.65V voltage rang @25±2°C of Cell under 0.5C/0.5C test condition and 100%DOD 80% EOL.</p>			

Technical Data		LX C138-10	LX C156-10
Usable Energy (kWh)* 1		138.24	156.67
Battery Module		LX C9.2-10: 38.4V 9.21kWh	
Number of Modules		15	17
Cell Type		LFP (LiFePO4)	
Cell Configuration		180S2P	204S2P
Nominal Voltage (V)		576	652.8
Operating Voltage Range (V)		504.0~639.0	571.2~724.2
Nominal Dis-/Charge Current (A)*2		100	
Nominal Power (kW)*2		57.60	65.28
Short-Circuit Current		4.2kA 0.57ms@639V.dc	4.3kA 0.53ms@724.2V.dc
Operating Temperature (°C)		Charge: 0 ~ +45 / Discharge: -20 ~ +50	
Relative Humidity(%)		0~95%	
Max. Operating Altitude (m)		2000	
Communication		CAN+RS485	
Weight (Kg)		1480	1650
Dimensions (W×H×D) (mm)		1155×2065×730	
Ingress Protection Rating		IP21	
Storage Temperature (°C)		0~+35 (< One Year); -20~0 or +35~+45 (< Three Months)	
Mounting Method		Grounded	
Round-trip Efficiency*1		96.0%	
Cycle Life*3		4000	
Standard and Certification	Safety	IEC62619, IEC62040, IEC63056	
	EMC	IEC/EN61000-6-1/2/3/4	
	Transportation	UN38.3	
<p>*1: Test conditions, 100% DOD, 0.2C charge &amp; discharge at +25±2 °C for battery system at beginning life. System Usable Energy may vary with different Inverter.</p> <p>*2: Nominal Charge/Discharge and power derating will occur related to Temperature and SOC.</p> <p>*3: Based on 2.5~3.65V voltage rang @25±2°C of Cell under 0.5C/0.5C test condition and 100%DOD 80% EOL.</p>			



GoodWe Website

## **GoodWe Technologies Co., Ltd.**

---

 No. 90 Zijin Rd., New District, Suzhou, 215011, China

 [www.goodwe.com](http://www.goodwe.com)

 [service@goodwe.com](mailto:service@goodwe.com)



Local Contacts