

# GOODWE



## Quick Installation Guide

### Rechargeable Li-ion Battery System

Lynx C Series

(LX C 101-10 | LX C120-10 | LX C138-10 | LX C156-10)

V1.0-2022-10-12

### General Disclaimer

---

- The information in this user manual is subject to change due to product updates or other reasons. This guide cannot replace the product labels or the safety precautions in the user manual unless otherwise specified. All descriptions in the manual are for guidance only.
- Read through the quick installation guide before installations. For additional information, please see the user manual.
- All operations should be performed by trained and knowledgeable technicians who are familiar with local standards and safety regulations.
- Check the deliverables for correct model, complete contents, and intact appearance. Contact After-sales Service for anything wrong.
- Use insulating tools and wear personal protective equipment (PPE) when operating the equipment to ensure personal safety.
- Strictly follow the installation, operation, and configuration instructions in this guide and relative user manual. The manufacturer shall not be liable for equipment damage or personal injury if you do not follow the instructions. For more warranty details, please visit <https://en.goodwe.com/warranty>.

### Safety Disclaimer

---

#### Instructions during Installation

















- Please keep Power Off before any operations to avoid danger. Strictly follow all safety precautions outlined in this manual and safety labels on the equipment.
- The Lynx C Series Rechargeable Li-ion Battery System for Commercials and Industries (hereinafter referred to as the Lynx C BS in short) is a high voltage system. Do not touch or operate it. Keep away from it. Only professionals are allowed!
- Please use appropriate tools and take protective measures when installing and maintaining heavy equipment. Improper operations will cause personal injuries.
- Do not use the battery module or Power Control Unit (PCU in short) if it is defective, broken, or damaged.
- Do not disassemble, modify, or replace any part of the battery module or PCU without official authorization from the manufacturer.
- Pay attention to the negative and positive during installation to avoid reverse polarity connection. Otherwise the short circuit may cause personal injuries and equipment damage.

#### Emergency Measures

Damaged battery modules may leak electrolyte. Do not contact with the liquid leakage or volatile gas. Please contact After-sales Service for help immediately.

- **Inhalation:** Evacuate from the contaminated area, and seek immediate medical assistance.
- **Eye contact:** Rinse your eyes for at least 15 minutes with clean water and seek immediate medical assistance.
- **Skin contact:** Thoroughly wash the touch area with soap and clean water, and seek immediate medical assistance.
- **Ingestion:** Induce vomiting, and seek immediate medical assistance.

## Label Description

Symbol	Description	Symbol	Description
	Potential risks exist. Wear proper PPE before any operations.		Keep the equipment away from open flame or ignition source.
	HIGH VOLTAGE HAZARD. High voltage exists during the equipment's running. Ensure the equipment is power off before any operations.		Keep the equipment away from children.
	Operate the equipment properly to avoid explosion.		No extinguishing with water.
	The equipment contains corrosive electrolytes. In case of a leak in the equipment, avoid contact the leaked liquid or gas.		Do not dispose of the equipment with household garbage at its end of life. Dispose it according to local laws and regulations. Or send it to the manufacturer.
	Batteries contain flammable materials. Beware of fire.		Put the battery in the right place and recycle it in compliance with local environmental regulations.
	Read through the user manual before any operations.		Pay attention to safety protection during installation, operation and maintenance.
	No stepping.		Grounding. To indicate PE cable connection position.
	CE Marking.		TUV Marking.
	RCM Marking.	-	-

## Check before Power ON

---

No.	Check Item
1	The equipment is firmly installed in a clean place where is well-ventilated and easy to operate.
2	Ensure that PE, the battery high voltage copper bus, the inverter power cable, the communication cable and single phase AC cable are connected correctly and securely.
3	Cable ties are intact, routed properly and evenly.

## EU Declaration of Conformity

---

The Lynx C BS sold in the European market meets the following directives and requirements:

- Electromagnetic compatibility Directive 2014/30/EU (EMC)
- Electrical Apparatus Low Voltage Directive 2014/35/EU (LVD)
- Restrictions of Hazardous Substances Directive 2011/65/EU and (EU) 2015/863 (RoHS)
- Waste Electrical and Electronic Equipment 2012/19/EU
- Registration, Evaluation, Authorization and Restriction of Chemicals (EC) No 1907/2006 (REACH)

You can download the EU Declaration of Conformity on the official website: <https://en.goodwe.com>.



Battery Cabinet

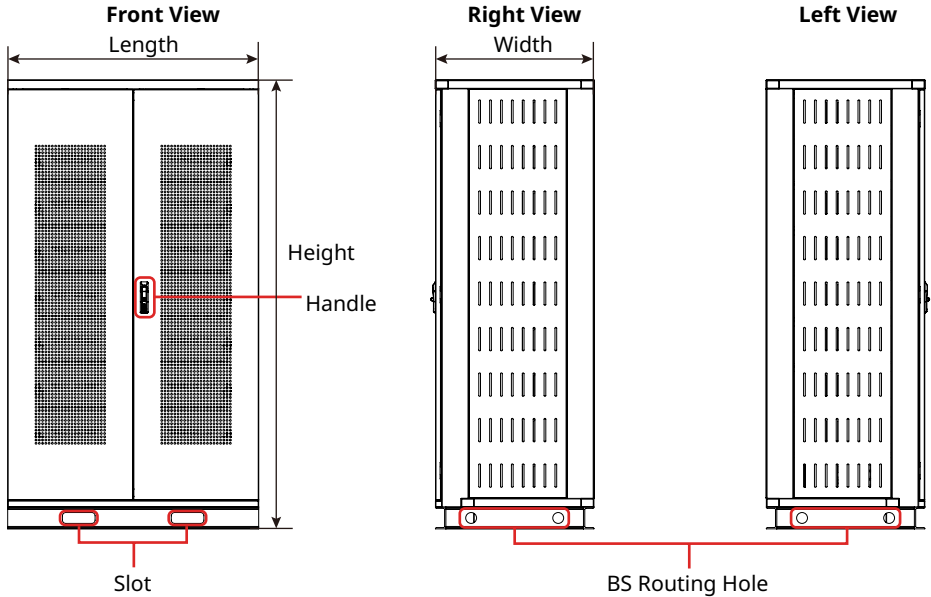

Model	Length (mm)	Width (mm)	Height (mm)
LX C101-10	1155	730	1650
LX C120-10			
LX C138-10	1155	730	2065
LX C156-10			

Power Control Unit (PCU)

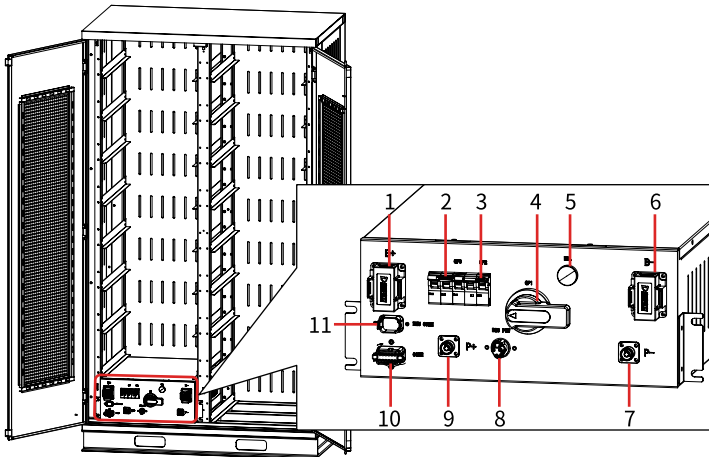

- |                                       |                         |                                       |
|---------------------------------------|-------------------------|---------------------------------------|
| 1. Battery Terminal (Positive)        | 2. DC Circuit Breaker   | 3. AC Circuit Breaker                 |
| 4. Main Circuit Breaker               | 5. Indicator            | 6. Battery Terminal (Negative)        |
| 7. Power Input/Output Port (Negative) | 8. AC Power Supply Port | 9. Power Input/Output Port (Positive) |
| 10. External COM Port                 | 11. Internal COM Port   |                                       |

**Battery Module**

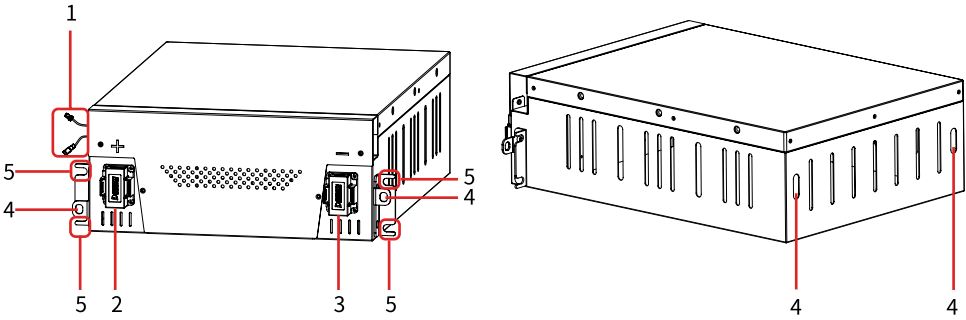

- |  |                              |                              |
|--|------------------------------|------------------------------|
| 1. Connector for Battery Communication | 2. Battery Positive Polarity | 3. Battery Negative Polarity |
| 4. Battery Hoisting Hole               | 5. Battery Fixing Hole       |                              |

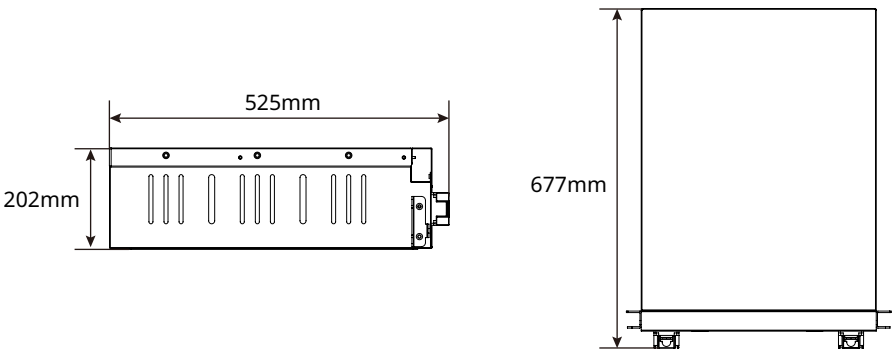

# 03 Installation

## Deliverables

### Battery Module

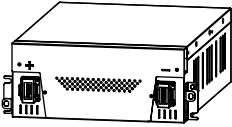

x N

### Battery Cabinet and Accessories

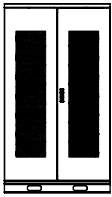

x 1

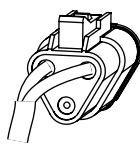

x 1

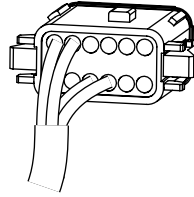

x 1

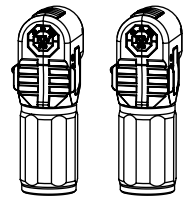

x 1



x 1



x 1

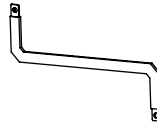

x N



x 1



x 1



x N

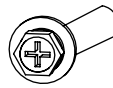

x N

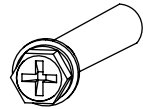

x N

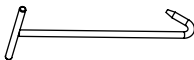

x 4



x N

NA

NA

N=Quantity depends on the specific system configuration.

## Space Requirements

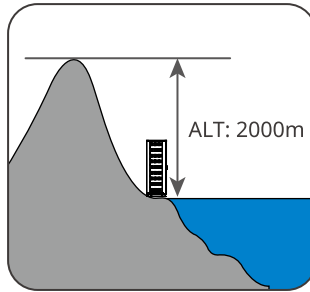
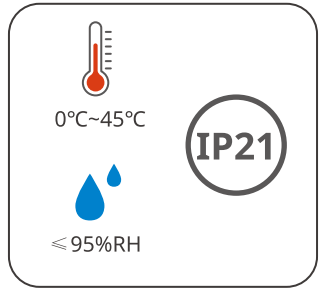
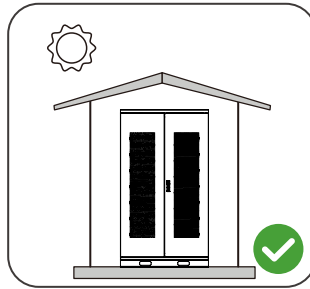
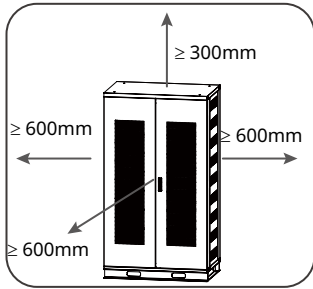

## Angle Requirements

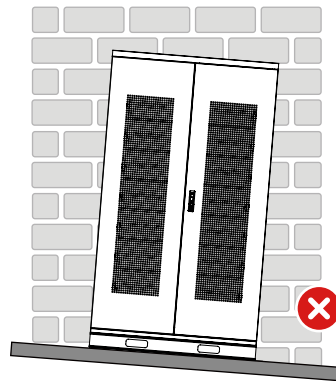
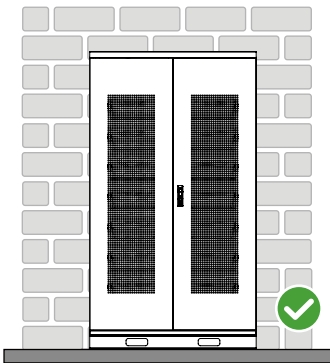

## BS Installation

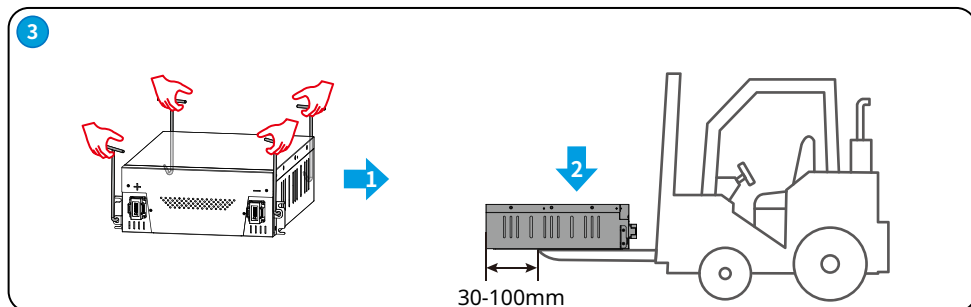
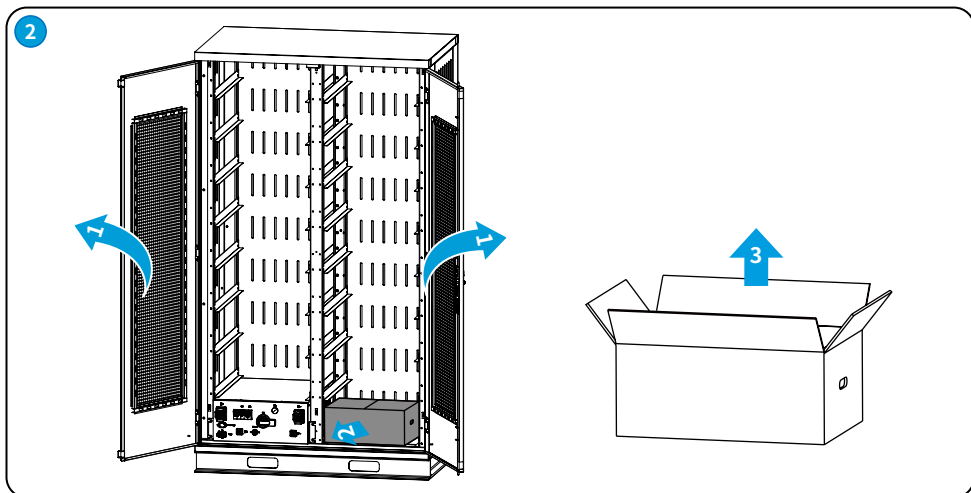
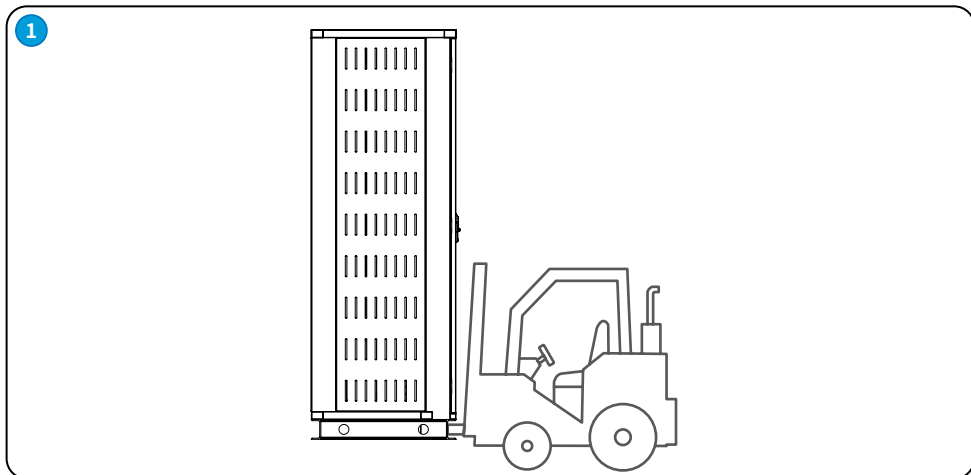

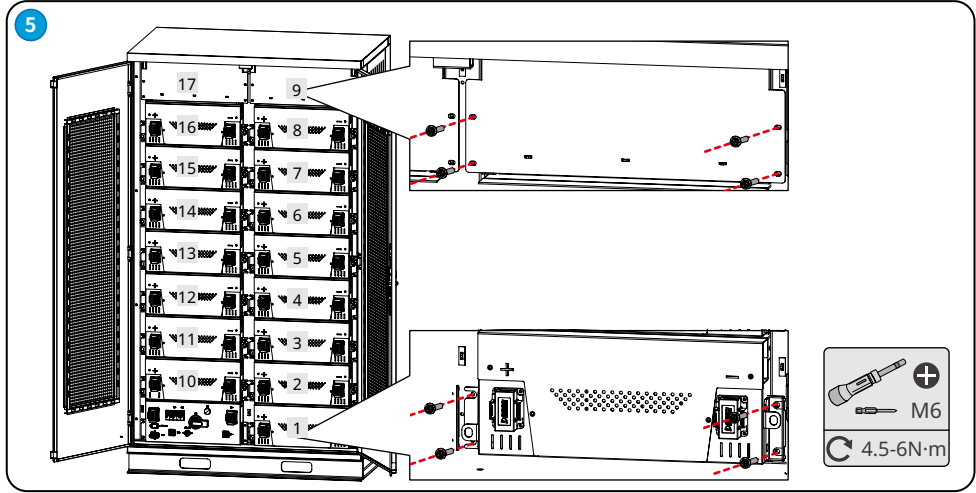
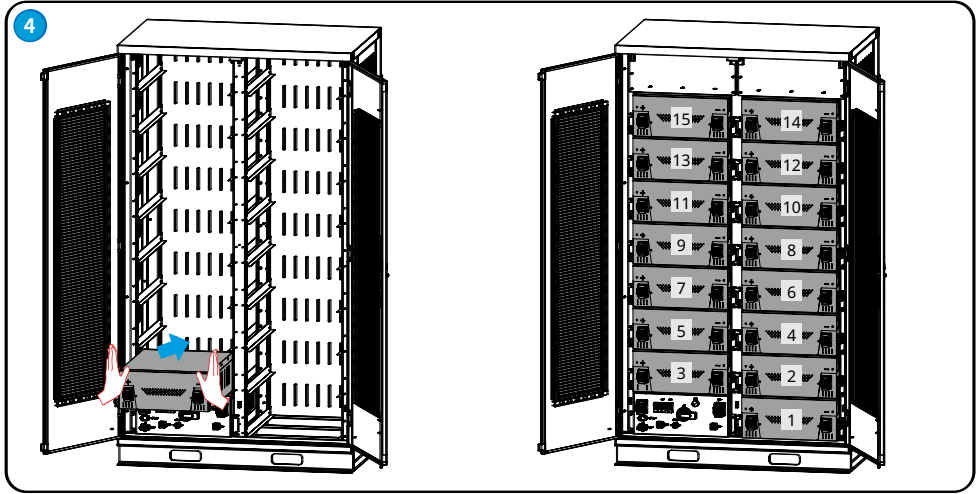

Cable Specification

No.	Cable	Type	Requirement
1	PE Cable	Single-core copper cable	Cross-sectional area of conductor $S_{PE}$ : 8mm <sup>2</sup> .
2	Power cable to connect with the inverter	The power cable shall be normal 1000V PV cables.	<ul style="list-style-type: none"> <li>Outer diameter of the cable: 11mm~13mm</li> <li>Cross-sectional area of conductor S: 35mm<sup>2</sup></li> </ul>
3	Others	Use the delivered cable or connecting bar.	

Connecting PE Cable

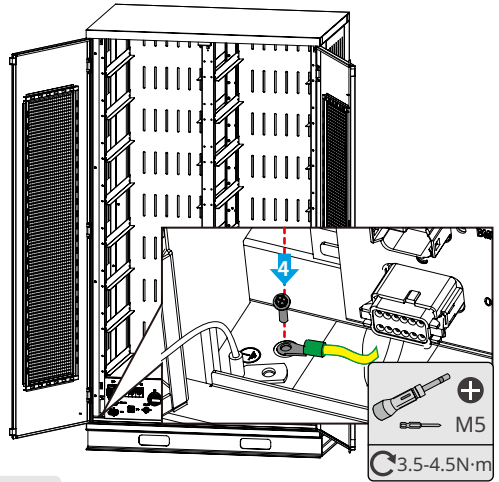
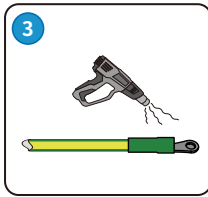
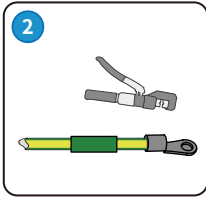
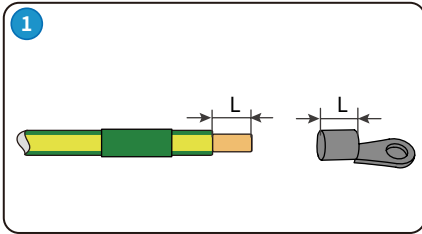

Connecting Inverter Communication Cable

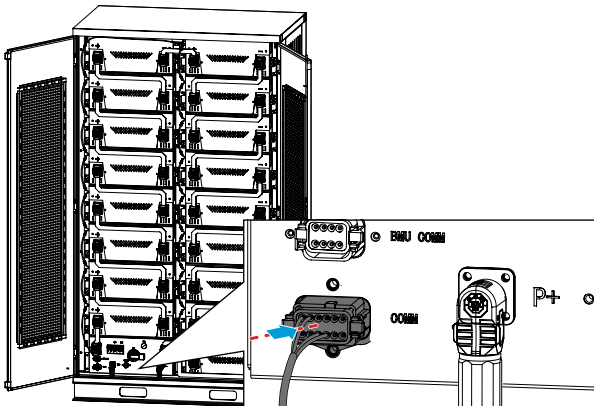

No.	Definition
3	CANH
4	CANL
7	RS485A
8	RS485B
Others	NA

## Connecting Battery Communication Cable

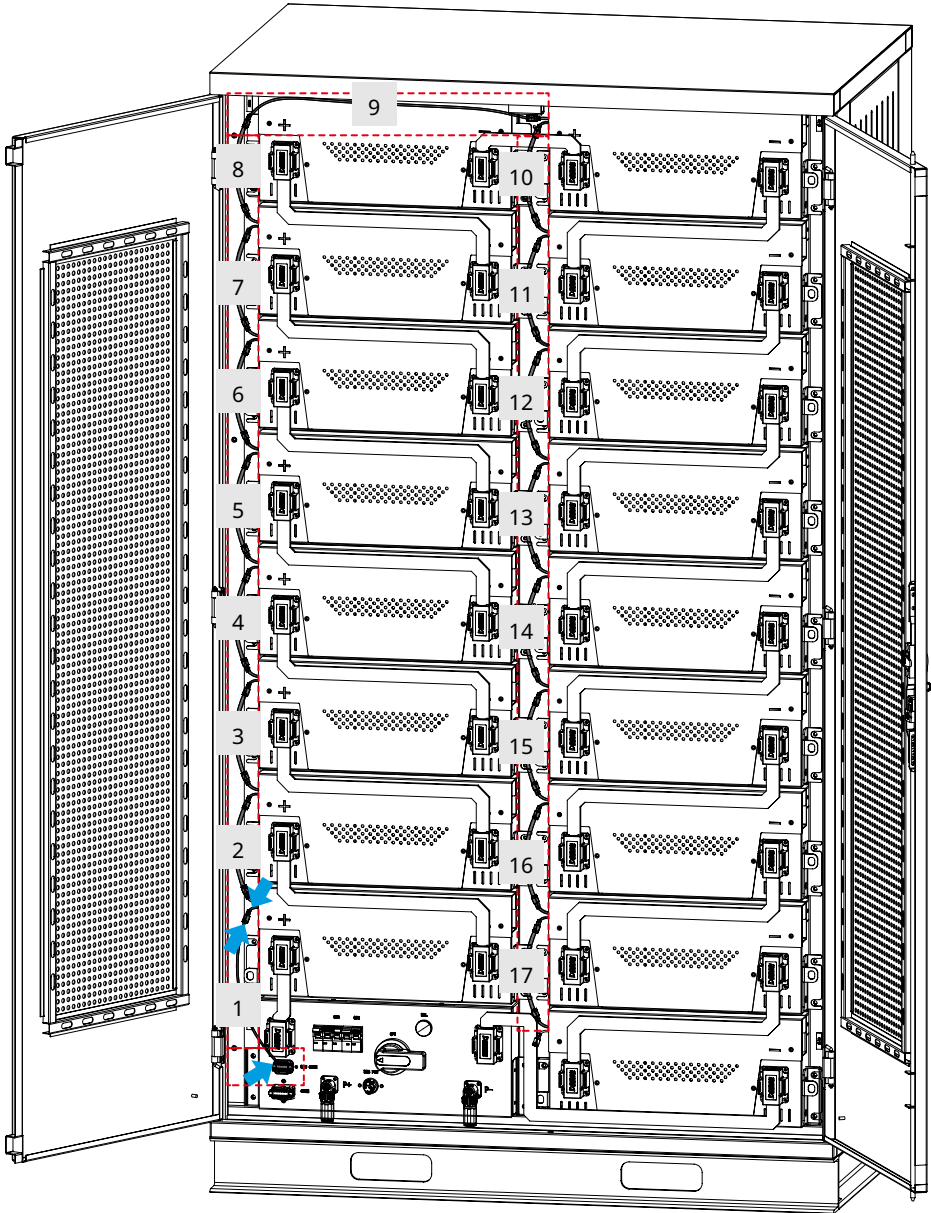



# Connecting Power Connecting Bar

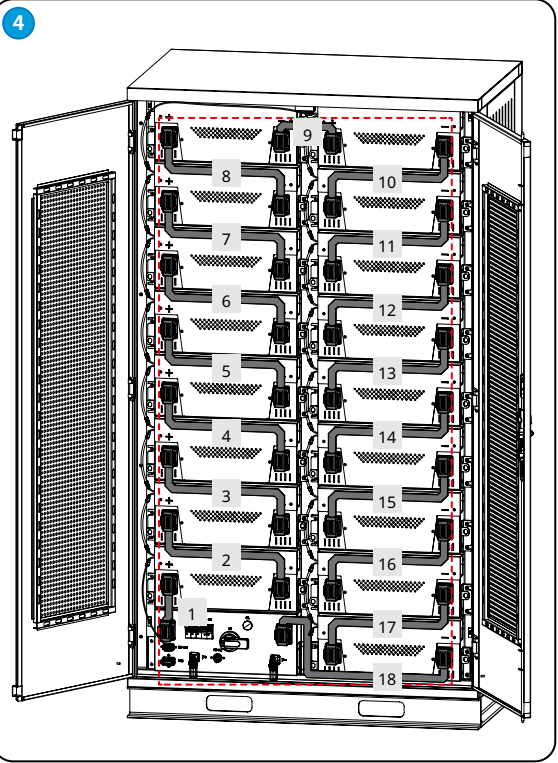
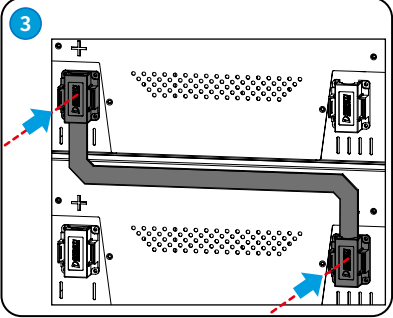
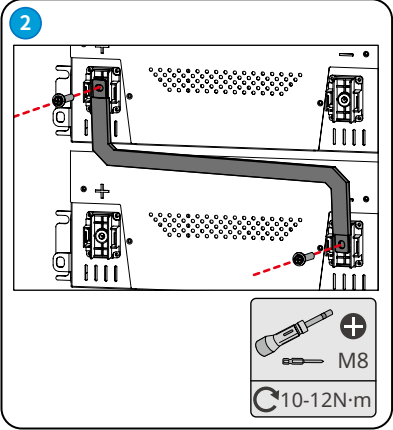
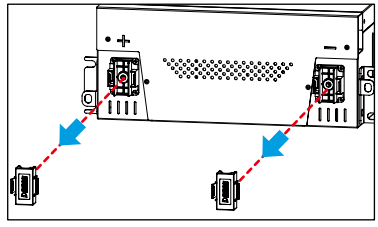
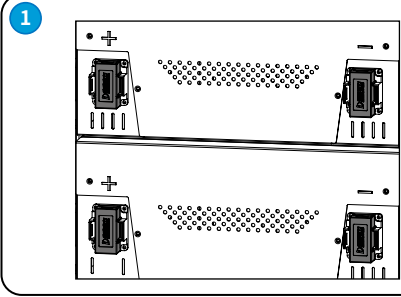

## Connecting Inverter Power Cable

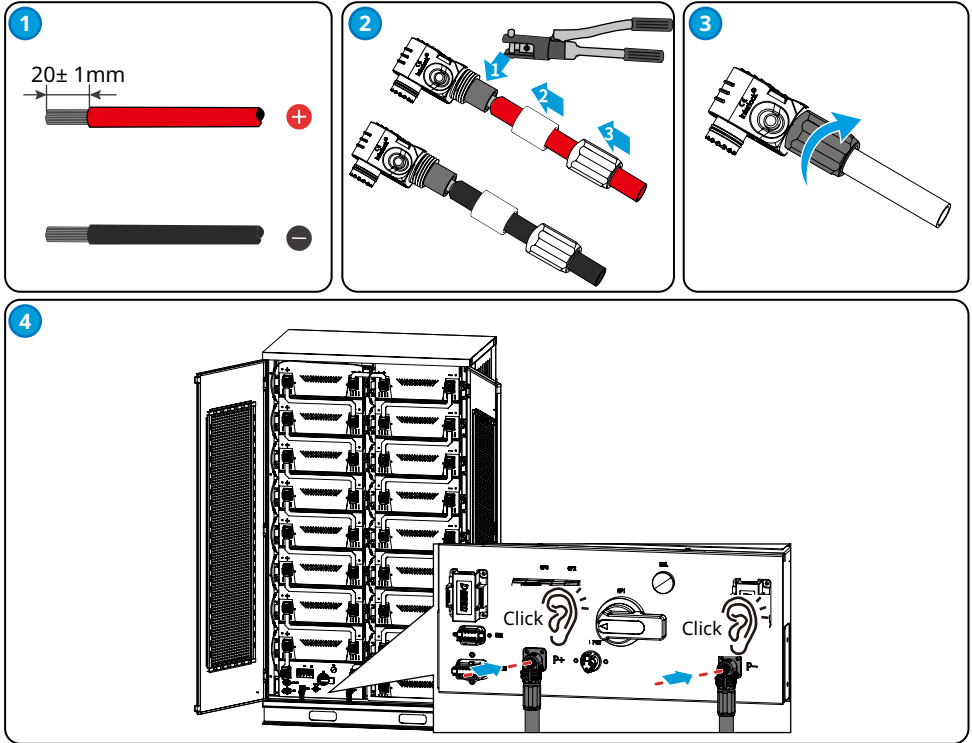

## (Optional) Connecting Single Phase AC Power Cable

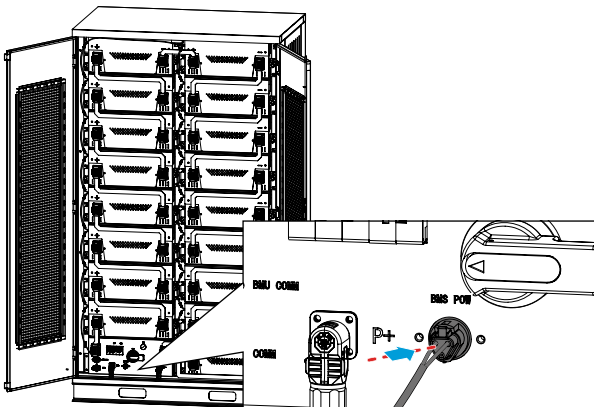

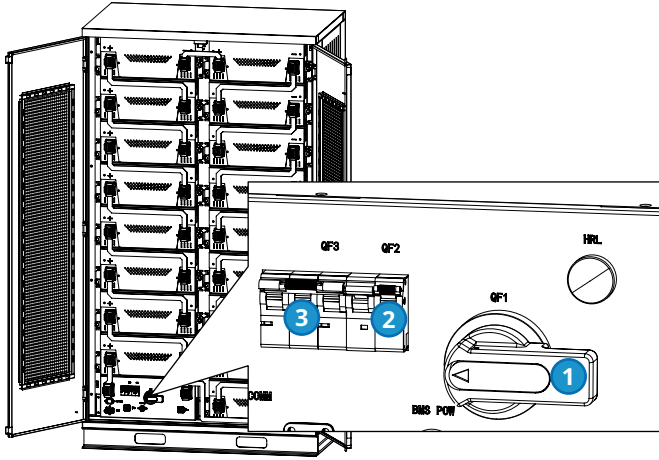
**Power ON**

Self-powered:



External single phase AC powering:

**Power OFF**

Self-powered:



External single phase AC powering:



### Commissioning via PV Master APP

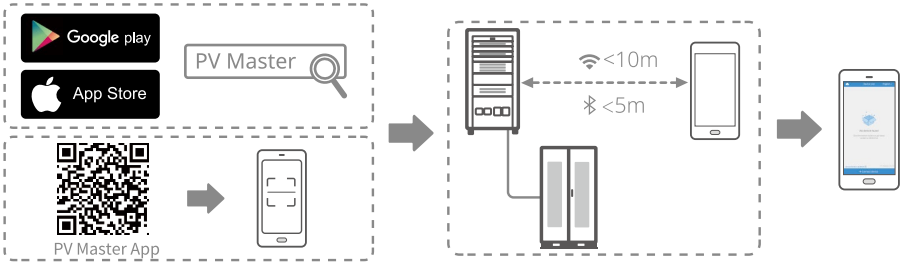

### Commissioning via SEMS Portal

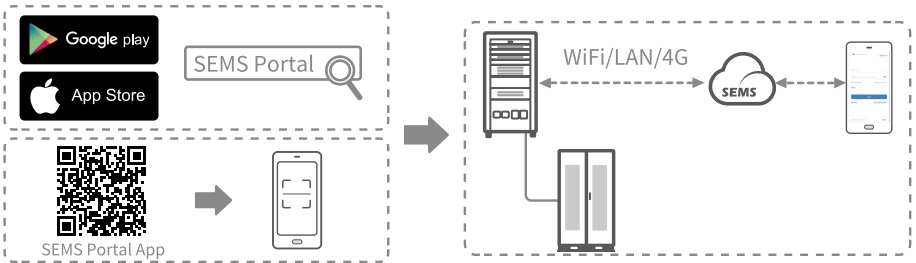

For more information, please scan the following QR for User Manual.



Lynx C Series  
User Manual



Official Website

**GoodWe Technologies Co., Ltd.**

---

 No. 90 Zijin Rd., New District, Suzhou, 215011, China

 [www.goodwe.com](http://www.goodwe.com)

 [service@goodwe.com](mailto:service@goodwe.com)



340-00870-00



Local Contacts